

Lockout / Tagout

Hazardous Energy Control LOTO Devices

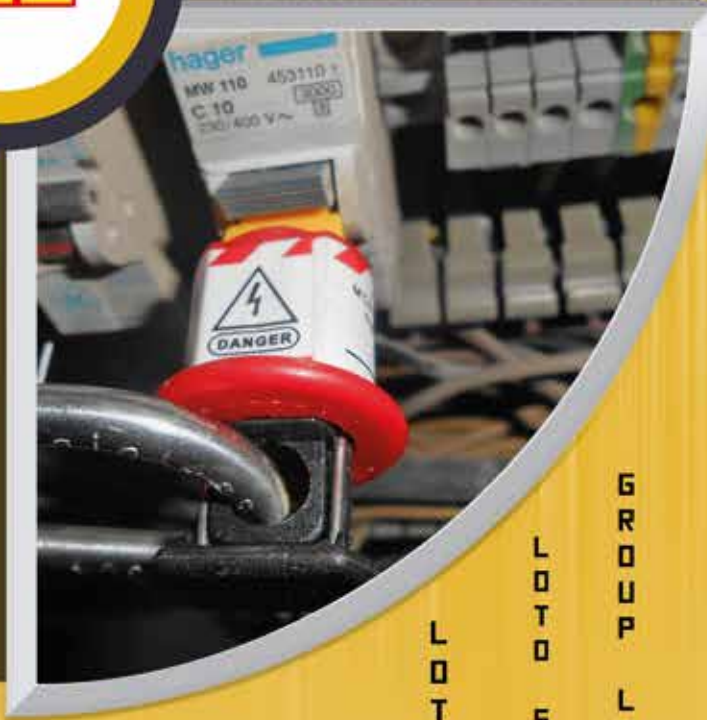

M E C H A N I C A L L O C K O U T S

V A L V E L O C K O U T S

C A B L E L O C K O U T S

K E Y C A B I N E T S

H A S P S

L O T O B A G S

L O T O S T A T I O N S

G R O U P L O C K O U T S

E L E C T R I C A L L O C K O U T S

HASPS

Model No.:	HSP-PMH-25R	
Description:	Hasp - Steel, PE Injection Molded	
	Handles, accommodates 6 Padlocks.	
	Size: Small, Color: Red.	
Size: 25 mm.	Dimensions:	
Brand: LOTO-LOK®	Origin: China	
Weight:	Packaging: 01 No.	



Model No.:	HSP-PMH-38R	
Description:	Hasp - Steel, PE Injection Molded	
	Handles, accommodates 6 Padlocks.	
	Size: Large, Color: Red.	
Size: 38 mm.	Dimensions:	
Brand: LOTO-LOK®	Origin: China	
Weight:	Packaging: 01 No.	



Model No.:	HSP-PMH-25B	
Description:	Hasp - Steel, PE Injection Molded	
	Handles, accommodates 6 Padlocks.	
	Size: Small, Color: Blue.	
Size: 25 mm.	Dimensions:	
Brand: LOTO-LOK®	Origin: China	
Weight:	Packaging: 01 No.	



Model No.:	HSP-PMH-38B	
Description:	Hasp - Steel, PE Injection Molded	
	Handles, accommodates 6 Padlocks.	
	Size: Large, Color: Blue.	
Size: 38 mm.	Dimensions:	
Brand: LOTO-LOK®	Origin: China	
Weight:	Packaging: 01 No.	



Model No.:	HSP-PMH-25Y	
Description:	Hasp - Steel, PE Injection Molded	
	Handles, accommodates 6 Padlocks.	
	Size: Small, Color: Yellow.	
Size: 25 mm.	Dimensions:	
Brand: LOTO-LOK®	Origin: China	
Weight:	Packaging: 01 No.	



Model No.:	HSP-PMH-38Y	
Description:	Hasp - Steel, PE Injection Molded	
	Handles, accommodates 6 Padlocks.	
	Size: Large, Color: Yellow.	
Size: 38 mm.	Dimensions:	
Brand: LOTO-LOK®	Origin: China	
Weight:	Packaging: 01 No.	



Model No.:	HSP-STL25-R	
Description:	Hasp - Steel, all metal construction for high temperature use. Accommodates 6 Padlocks. Color: Red.	
	Size: Small - 25mm	
	Dimensions:	
Brand: LOTO-LOK®	Origin: China	
Weight:	Packaging: 01 No.	



Model No.:	HSP-TAB-25	
Description:	Hasp - Steel, PE Injection Molded	
	Handles with Double Locking Tabs.	
	Size: Small, Color: Red.	
Size: 25 mm.	Dimensions:	
Brand: LOK-FORCE™	Origin: China	
Weight:	Packaging: 01 No.	



Model No.:	HSP-TAB-38	
Description:	Hasp - Steel, PE Injection Molded	
	Handles with Double Locking Tabs.	
	Size: Large, Color: Red.	
Size: 38 mm.	Dimensions:	
Brand: LOK-FORCE™	Origin: China	
Weight:	Packaging: 01 No.	



HASPS

Model No.:	HSP-AL-25	
Description:	Hasp - Aluminum Round Rod Scissor	
	Hasp, Nylon Injection Molded Handles. Size: Small. Color: Red.	
Size: 25 mm.	Dimensions:	
Brand: LOTO-LOK®	Origin: China	
Weight:	Packaging: 01 No.	



Model No.:	HSP-AL-38	
Description:	Hasp - Aluminum Round Rod Scissor	
	Hasp, Nylon Injection Molded Handles. Size: Large. Color: Red.	
Size: 38 mm.	Dimensions:	
Brand: LOTO-LOK®	Origin: China	
Weight:	Packaging: 01 No.	



Model No.:	HSP-SS316-25	
Description:	Hasp - Solid SS 316 Grade, Rust, Weather & Spark proof Hasp.	
	Accommodates 6 Padlocks.	
Size:	Dimensions:	
Brand: LOTO-LOK®	Origin: China	
Weight:	Packaging: 01 No.	



Model No.:	HSP-ALDS-2538	
Description:	Hasp - Aluminum, Dual jaw size	
	25/38 mm, Accommodates 8 Locks.	
Size: 25 x 38 mm.	Dimensions:	
Brand:	Origin: China	
Weight:	Packaging: 01 No.	



Model No.:	HSP-RNH-33	
Description:	Hasp - Nylon, Non-Conductive,	
	3.0mm Shackle diameter. Accommodates 3 Padlocks. Color: Red.	
Shackle dia: 3.0mm .		
Brand: LOTO-LOK®	Origin: China	
Weight:	Packaging: 01 No.	



Model No.:	HSP-RNH-36	
Description:	Hasp - Nylon, Non-Conductive,	
	6.0mm Shackle diameter. Accommodates 3 Padlocks. Color: Red.	
Shackle dia: 6.0 mm.		
Brand: LOTO-LOK®	Origin: China	
Weight:	Packaging: 01 No.	



Model No.:	HSP-RNH-65	
Description:	Hasp - Nylon, Non-Conductive,	
	5.0mm Shackle diameter. Accommodates 6 Padlocks. Color: Red.	
Shackle dia: 5.0 mm.		
Brand: LOTO-LOK®	Origin: China	
Weight:	Packaging: 01 No.	



Model No.:	HSP-RNH-66	
Description:	Hasp - Nylon, Non-Conductive,	
	6.0mm Shackle diameter. Accommodates 6 Padlocks. Color: Red.	
Shackle dia: 6.0 mm.		
Brand: LOTO-LOK®	Origin: China	
Weight:	Packaging: 01 No.	



Model No.:	HSP-DEY3	
Description:	Hasp - Nylon, Di-Electric	
	3.0mm Shackle diameter. Accommodates 4 Padlocks. Color: Yellow / Red.	
Shackle dia: 3.0 mm.		
Brand: LOTO-LOK®	Origin: China	
Weight:	Packaging: 01 No.	



HASPS

Model No.:	HSP-DEY6	
Description:	Hasp – Nylon, Di-Electric	
	6.0mm Shackle diameter. Accommodates 4 Padlocks. Color: Yellow / Red.	
Shackle dia: 6.0 mm.		
Brand: LOTO-LOK®	Origin: China	
Weight:	Packaging: 01 No.	
		

Model No.:	HSP-SBS	
Description:	Hasp – Steel, SHORT Shackle, Butterfly Type, Accommodates 4 Padlocks.	
	Dimensions: H82 x W60 x 10mm Dia.	
Brand:	Origin: China	
Weight:	Packaging: 01 No.	
		

Model No.:	HSP-SBL	
Description:	Hasp – Steel, LONG Shackle, Butterfly Type, Accommodates 8 Padlocks.	
	Dimensions: H168 x W60 x 10mm Dia.	
Brand:	Origin: China	
Weight:	Packaging: 01 No.	
		

Model No.:	HSP-ALR-6	
Description:	Hasp – Aluminum Alloy. Accommodates 6 Padlocks. Color: Red.	
	Dimensions: W77 x L190 mm.	
Brand:	Origin: China	
Weight:	Packaging: 01 No.	
		

Model No.:	HSP-ALH-25Y	
Description:	Hasp – Aluminium with coated non-conductive shackle. 6 locks capacity. Color: Yellow / Black.	
	Dimensions:	
Brand:	Origin: China	
Weight:	Packaging: 01 No.	
		

Model No.:	HSP-TS3-4L	
Description:	Hasp – Nylon body with 3.5mm Steel shackle for small apertures. 4 Locks capacity. Color: Red.	
	Shackle dia: 3.5mm Dia.	
Brand: LOTO-LOK®	Origin: China	
Weight:	Packaging: 01 No.	
		

Model No.:	HSP-SCORP	
Description:	Hasp – Steel, Dual jaw size 25/38mm, Accommodates 6 Locks. Color: Red.	
	Dimensions: Standard	
Brand:	Origin: China	
Weight:	Packaging: 01 No.	
		

Model No.:	HSP-MST-724	
Description:	Hasp – Aluminium with Snap-On Clip. Accommodates 5 padlocks. Available in 6 color labels Red, Yellow, Green, Blue, Orange & Black.	
	Dimensions: 1-3/4in x 2-1/8in (44.5mm x 54mm) Jaw Clearance.	
Brand:	Origin: China	
Weight:	Packaging: 01 No.	
		

CABLE LOCKOUTS

Model No.:	CL-PM-2MB
Description:	Cable Lockout - Premier
	Multipurpose Lockout + Hasp function. Color: Red. Cable: Black.
Cable Size: Dia. 4.0mm x Length 1.80 Mtr.	
Brand: LOTO-LOK®	Origin: China
Weight:	Packaging: 01 No.
	

Model No.:	CL-SQCL-1.5MR
Description:	Cable Lockout - Economy Squeezer
	Multipurpose, Galv. steel cable PVC coated with brass end cap. Color: Red.
Cable Size: Dia. 3.8mm x Length 1.50 Mtr.	
Brand: LOTO-LOK®	Origin: China
Weight:	Packaging: 01 No.
<p>Metal cable with PVC coating - One type cable ONLY red color</p> 	

Model No.:	CL-SQALM-1.5MC
Description:	Cable Lockout - Aluminium body,
	SS 304 cable. Ideal for high heat and extreme temperatures. 8 padlock holes.
Color: Satin.	
Cable Size: Dia. 4.0mm x 1.5 mtrs length.	
Brand: LOTO-LOK®	Origin: China
Weight:	Packaging: 01 No.
	

Model No.:	CL-SQC-3225
Description:	Cable Lockout - Grip Type with NYLON
	cable for locking multiple isolators and panels. ABS & PC construction,
accommodates 4 Padlocks. Cable Length: 2.5 Mtrs.	
Cable Diameter: 3.2mm. Color: Red.	
Brand: LOQ-IT	Origin: China
Weight:	Packaging: 01 No.
	

Model No.:	CL-SQC-5025
Description:	Cable Lockout - Grip Type with STEEL
	PVC Coated Cable. ABS & PC construction accommodates 4 Padlocks. Color: Red.
Cable Length: 2.5 Mtrs. Cable Diameter: 5.0mm.	
Brand: LOQ-IT	Origin: China
Weight:	Packaging: 01 No.
	

Model No.:	CL-3F-4MC
Description:	Cable Lockout - Adjustable with
	Stainless Steel PVC coated cable with brass end cap. Color: Red.
Cable Size: Dia. 5/32" (4mm) x Length 0.9 Mtrs.	
Brand: LOQ-IT	Origin: China
Weight:	Packaging: 01 No.
	

Model No.:	CL-5F-4MC
Description:	Cable Lockout - Adjustable with
	Stainless Steel PVC coated cable with brass end cap. Color: Red.
Cable Size: Dia. 5/32" (4mm) x Length 1.5 Mtrs.	
Brand: LOQ-IT	Origin: China
Weight:	Packaging: 01 No.
	

Model No.:	CL-6F-4MC
Description:	Cable Lockout - Adjustable with
	Stainless Steel PVC coated cable with brass end cap. Color: Red.
Cable Size: Dia. 5/32" (4mm) x Length 1.8 Mtrs.	
Brand: LOQ-IT	Origin: China
Weight:	Packaging: 01 No.
	

Model No.:	CL-16F-4MC
Description:	Cable Lockout - Adjustable with
	Stainless Steel PVC coated cable with brass end cap. Color: Red.
Cable Size: Dia. 5/32" (4mm) x Length 5.0 Mtrs.	
Brand: LOQ-IT	Origin: China
Weight:	Packaging: 01 No.
	

CABLE LOCKOUTS

Model No.:	CL-6F-6MC
Description:	Cable Lockout - Adjustable with
	Stainless Steel PVC coated cable with brass end cap. Color: Red.
Cable Size: Dia. 1/4" (6mm) x Length 1.8 Mtrs.	
Brand: LOQ-IT	Origin: China
Weight:	Packaging: 01 No.
	

Model No.:	CL-FT-2MR
Description:	Cable Lockout - FISH type.
	PVC coated cable with brass end cap. Color: Red.
Cable Size: Dia. 5.0mm x Length 2.0 Mtrs.	
Brand:	Origin: China
Weight:	Packaging: 01 No.
	

Model No.:	CL-PSM-2MR
Description:	Cable Lockout - Premium Squeezer
	Multipurpose with Vinyl Coated Steel Cable. Color: Red.
Cable Size: Dia. 3.50mm x Length 2.0 Mtrs.	
Brand:	Origin: China
Weight:	Packaging: 01 No.
	

Model No.:	CL-UNI-3MC
Description:	Cable Lockout - GRIP-ON with
	spring cable locking mechanism. PVC coated with brass end cap.
Color: Red. Cable Size: Dia. 4.0mm x Length 1.6 Mtrs.	
Brand:	Origin: China
Weight:	Packaging: 01 No.
	

Model No.:	CL-FLX-6FB
Description:	Cable Lockout - HASP type
	Multipurpose applications. Black PVC coated cable with brass end cap.
Color: Red. Cable Size: Dia. 4.8mm x Length 1.8 Mtrs.	
Brand:	Origin: China
Weight:	Packaging: 01 No.
	

Model No.:	CL-UM-2MY
Description:	Cable Lockout - WHEEL type.
	PVC coated cable with brass end cap. Color: Yellow.
Cable Size: Dia. 4.0mm x Length 2.0 Mtrs.	
Brand:	Origin: China
Weight:	Packaging: 01 No.
	

KAB-O-LOK™ CABLE LOCKOUTS

Model No.:	CL-DEVR
Description:	Cable Lockout - Comprises Base +
	Tightening Wheel. Manufactured from heat resistant Nylon PA66 Color: Red.
Diameter 73mm x Height 37 mm.	
Brand: KAB-O-LOK™	Origin: China
Weight:	Packaging: 01 No.



Comprises Base & Tightening Wheel (Front Side)



Cable Management System (Back Side)

Model No.:	KABTOOL-R
Description:	KAB-TOOL Operating Tool for
	KAB-O-LOK™ Cable Lockout. Color: Red.
Diameter 76mm x Height 13 mm.	
Brand: KAB-O-LOK™	Origin: China
Weight:	Packaging: 01 No.



FRONT



BACK

Watch how KAB-O-LOK's superior features and function can save \$\$\$\$ on reducing downtime compared to similar cable lockouts.

https://www.youtube.com/watch?v=qHf1_b6FHfs

(3D Animation of KAB-O-LOK function and features)

https://www.youtube.com/watch?v=-a_9Qpy4Nzl

(Live demonstration of locking valves with KAB-O-LOK cable lockout)

COMPONENTS

Comprises Base & Tightening Wheel with Steel Galvanized PVC Coated Cable



KAB-TOOL Operating Tool for KAB-O-LOK™ Cable



CABLE MANAGEMENT SYSTEM

KAB-O-LOK™ CABLE LOCKOUTS

Model No.:	CL-DEVY
Description:	Cable Lockout - Comprises Base +
	Tightening Wheel. Manufactured from heat resistant Nylon PA66 Color: Yellow.
Diameter 73mm x Height 37 mm.	
Brand: KAB-O-LOK™	Origin: China
Weight:	Packaging: 01 No.



Comprises Base & Tightening Wheel (Front Side)

Cable Management System (Back Side)

Model No.:	KABTOOL-Y
Description:	KAB-TOOL Operating Tool for
	KAB-O-LOK™ Cable Lockout. Color: Yellow.
Diameter 76mm x Height 13 mm.	
Brand: KAB-O-LOK™	Origin: China
Weight:	Packaging: 01 No.

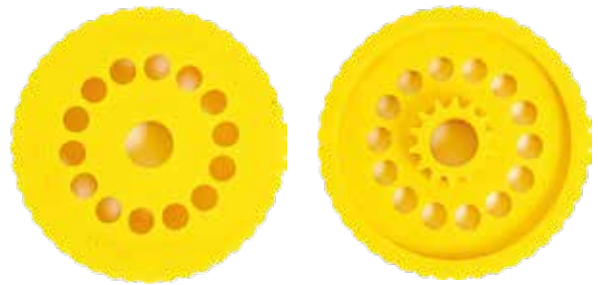

FRONT

BACK

Model No.:	CL-DEVG
Description:	Cable Lockout - Comprises Base +
	Tightening Wheel. Manufactured from heat resistant Nylon PA66 Color: Green.
Diameter 73mm x Height 37 mm.	
Brand: KAB-O-LOK™	Origin: China
Weight:	Packaging: 01 No.



Comprises Base & Tightening Wheel (Front Side)

Cable Management System (Back Side)

Model No.:	KABTOOL-G
Description:	KAB-TOOL Operating Tool for
	KAB-O-LOK™ Cable Lockout. Color: Green.
Diameter 76mm x Height 13 mm.	
Brand: KAB-O-LOK™	Origin: China
Weight:	Packaging: 01 No.



FRONT

BACK

PVC COATED CABLES FOR KAB-O-LOK™

Model No.:	CL-CAB2R
Description:	Cable - Steel Galvanised PVC coated with Aluminium eye at one end and crimped brass cap at other end. Color: Red.
Dimensions: I.D. 2.5mm x O.D. 3.8mm x L 2.0 Mtrs.	
Brand: KAB-O-LOK™	Origin: China
Weight:	Packaging: 01 No.
	

Model No.:	CL-CAB5R
Description:	Cable - Steel Galvanised PVC coated with Aluminium eye at one end and crimped brass cap at other end. Color: Red.
Dimensions: I.D. 2.5mm x O.D. 3.8mm x L 5.0 Mtrs.	
Brand: KAB-O-LOK™	Origin: China
Weight:	Packaging: 01 No.
	

Model No.:	CL-CAB10R
Description:	Cable - Steel Galvanised PVC coated with Aluminium eye at one end and crimped brass cap at other end. Color: Red.
Dimensions: I.D. 2.5mm x O.D. 3.8mm x L 10.0 Mtrs.	
Brand: KAB-O-LOK™	Origin: China
Weight:	Packaging: 01 No.
	

Model No.:	CL-CAB2Y
Description:	Cable - Steel Galvanised PVC coated with Aluminium eye at one end and crimped brass cap at other end. Color: Yellow.
Dimensions: I.D. 2.5mm x O.D. 3.8mm x L 2.0 Mtrs.	
Brand: KAB-O-LOK™	Origin: China
Weight:	Packaging: 01 No.
	

Model No.:	CL-CAB5Y
Description:	Cable - Steel Galvanised PVC coated with Aluminium eye at one end and crimped brass cap at other end. Color: Yellow.
Dimensions: I.D. 2.5mm x O.D. 3.8mm x L 5.0 Mtrs.	
Brand: KAB-O-LOK™	Origin: China
Weight:	Packaging: 01 No.
	

Model No.:	CL-CAB10Y
Description:	Cable - Steel Galvanised PVC coated with Aluminium eye at one end and crimped brass cap at other end. Color: Yellow.
Dimensions: I.D. 2.5mm x O.D. 3.8mm x L 10.0 Mtrs.	
Brand: KAB-O-LOK™	Origin: China
Weight:	Packaging: 01 No.
	

Model No.:	CL-CAB2G
Description:	Cable - Steel Galvanised PVC coated with Aluminium eye at one end and crimped brass cap at other end. Color: Green.
Dimensions: I.D. 2.5mm x O.D. 3.8mm x L 2.0 Mtrs.	
Brand: KAB-O-LOK™	Origin: China
Weight:	Packaging: 01 No.
	

Model No.:	CL-CAB5G
Description:	Cable - Steel Galvanised PVC coated with Aluminium eye at one end and crimped brass cap at other end. Color: Green.
Dimensions: I.D. 2.5mm x O.D. 3.8mm x L 5.0 Mtrs.	
Brand: KAB-O-LOK™	Origin: China
Weight:	Packaging: 01 No.
	

Model No.:	CL-CAB10G
Description:	Cable - Steel Galvanised PVC coated with Aluminium eye at one end and crimped brass cap at other end. Color: Green.
Dimensions: I.D. 2.5mm x O.D. 3.8mm x L 10.0 Mtrs.	
Brand: KAB-O-LOK™	Origin: China
Weight:	Packaging: 01 No.
	

KAB-O-LOK™ ACCESSORIES

Model No.:	CL-SPL-RD50M
Description:	CABLE SPOOL - Steel Galvanised
	PVC coated Cable. Color: Red.
	Cable Length: 50.0 Mtrs.
Size: (I.D. 2.5mm x O.D. 3.8mm)	
Brand: KAB-O-LOK™	Origin: China
Weight:	Packaging:

Spool of 50 Mtrs. Per Roll.



Model No.:	CL-SPL-GN50M
Description:	CABLE SPOOL - Steel Galvanised
	PVC coated Cable. Color: Green.
	Cable Length: 50.0 Mtrs.
Size: (I.D. 2.5mm x O.D. 3.8mm)	
Brand: KAB-O-LOK™	Origin: China
Weight:	Packaging:

Spool of 50 Mtrs. Per Roll.



Model No.:	CL-SPL-YL50M
Description:	CABLE SPOOL - Steel Galvanised
	PVC coated Cable. Color: Yellow.
	Cable Length: 50.0 Mtrs.
Size: (I.D. 2.5mm x O.D. 3.8mm)	
Brand: KAB-O-LOK™	Origin: China
Weight:	Packaging:

Spool of 50 Mtrs. Per Roll.



Model No.:	FRL-AL
Description:	Ferrule, Aluminium for crimping
	bare / coated cables up to 3.8mm dia.
Brand:	Origin: China
Weight:	Packaging:

Pack of 50 Pcs.



WHEEL VALVE LOCKOUTS

Model No.:	VL-PGT-2563
Description:	Valve Lockout - PREMIER.
	Locks Wheel Valves dia. between 25 - 63 mm. Color: Red.
Size: 25 - 63 mm.	
Brand: LOTO-LOK®	Origin: China
Weight:	Packaging:
	

Model No.:	VL-PGT-63125
Description:	Valve Lockout - PREMIER.
	Locks Wheel Valves dia. between 63 - 125 mm. Color: Red.
Size: 63 - 125 mm.	
Brand: LOTO-LOK®	Origin: China
Weight:	Packaging:
	

Model No.:	VL-PGT-125165
Description:	Valve Lockout - PREMIER.
	Locks Wheel Valves dia. between 125 - 165 mm. Color: Red.
Size: 125 - 165 mm.	
Brand: LOTO-LOK®	Origin: China
Weight:	Packaging:
	

Model No.:	VL-PGT-165250
Description:	Valve Lockout - PREMIER.
	Locks Wheel Valves dia. between 165 - 250 mm. Color: Red.
Size: 165 - 250 mm.	
Brand: LOTO-LOK®	Origin: China
Weight:	Packaging:
	

Model No.:	VL-PGT-250325
Description:	Valve Lockout - PREMIER.
	Locks Wheel Valves dia. between 250 - 325 mm. Color: Red.
Size: 250 - 325 mm.	
Brand: LOTO-LOK®	Origin: China
Weight:	Packaging:
	

Model No.:	VL-PGT-330450
Description:	Valve Lockout - PREMIER.
	Locks Wheel Valves dia. between 330 - 450 mm. Color: Red.
Size: 330 - 450 mm.	
Brand: LOTO-LOK®	Origin: China
Weight:	Packaging:
	

Model No.:	VL-PGT-25325
Description:	Valve Lockout - PREMIER.
	Locks Wheel Valves dia. between 25 - 325 mm. Color: Red.
(Set of 5 Pcs. Consisting of 25mm to 325mm)	
Size: 25 - 325 mm.	
Brand: LOTO-LOK®	Origin: China
Weight:	Packaging:
	

Model No.:	VL-PGT-25450
Description:	Valve Lockout - PREMIER.
	Locks Wheel Valves dia. between 25 - 450 mm. Color: Red.
(Set of 6 Pcs. Consisting of 25mm to 450mm)	
Size: 25 - 450 mm.	
Brand: LOTO-LOK®	Origin: China
Weight:	Packaging:
	

Model No.:	VL-GVLA-25125
Description:	Adjustable Gate Valve Lockout.
	Locks Valve Wheel Diameters between 25 - 125 mm.
Size: 25 - 125 mm.	
Brand: LOTO-LOK®	Origin: China
Weight:	Packaging:
	

WHEEL VALVE LOCKOUTS

Model No.:	VL-MST-F480
Description:	Valve Lockout - ROTATING.
	Locks Valve Wheel Dia. between 25 - 76 mm.
Size: 25 - 76 mm.	
Brand:	Origin: China
Weight:	Packaging:
	

Model No.:	VL-MST-F481
Description:	Valve Lockout - ROTATING.
	Locks Valve Wheel Dia. between 50 - 127 mm.
Size: 50 - 127 mm.	
Brand:	Origin: China
Weight:	Packaging:
	

Model No.:	VL-MST-F482
Description:	Valve Lockout - ROTATING.
	Locks Valve Wheel Dia. between 101 - 165 mm.
Size: 101 - 165 mm.	
Brand:	Origin: China
Weight:	Packaging:
	

Model No.:	VL-MST-F483
Description:	Valve Lockout - ROTATING.
	Locks Valve Wheel Dia. between 152 - 254 mm.
Size: 152 - 254 mm.	
Brand:	Origin: China
Weight:	Packaging:
	

Model No.:	VL-MST-F484
Description:	Valve Lockout - ROTATING.
	Locks Valve Wheel Dia. between 203 - 330 mm.
Size: 203 - 330 mm.	
Brand:	Origin: China
Weight:	Packaging:
	

Model No.:	VL-MST-F485
Description:	Valve Lockout - ROTATING.
	Locks Valve Wheel Dia. between 25 - 330 mm.
Size: 25 - 330 mm.	
Brand:	Origin: China
Weight:	Packaging:
<p>(Set of 5 Pcs. Consisting of F480 to F484)</p> 	

BALL VALVE LOCKOUTS

Model No.:	VL-BV-1032TL
Description:	Valve Lockout - BALL (Lever type).
	Locks Valve Sizes: 10 - 32 mm.
	Polypropylene construction. Color: Red.
Size: 10 - 32 mm.	
Brand:	Origin: China
Weight:	Packaging:



Model No.:	VL-BV-1364TL
Description:	Valve Lockout - BALL (Lever type).
	Locks Valve Sizes: 13 - 64 mm.
	Polypropylene construction. Color: Red.
Size: 13 - 64 mm.	
Brand:	Origin: China
Weight:	Packaging:



Model No.:	VL-BV-50200TL
Description:	Valve Lockout - BALL (Lever type).
	Locks Valve Sizes: 50 - 200 mm.
	Polypropylene construction. Color: Red.
Size: 50 - 200 mm.	
Brand:	Origin: China
Weight:	Packaging:

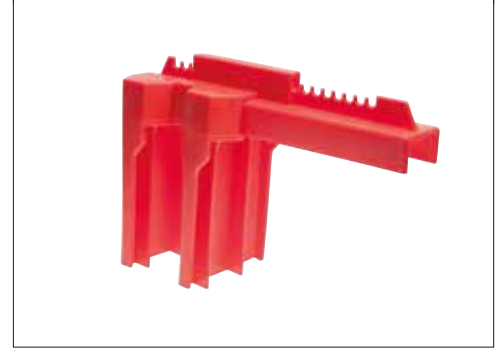

Model No.:	VL-BV-625STL
Description:	Valve Lockout - BALL
	(Steel Powder coated.) Color: Red.
	Locks Valve Sizes: 6 - 25 mm.
Size: 6 - 25 mm.	
Brand:	Origin: China
Weight:	Packaging:



Model No.:	VL-BV-3276STL
Description:	Valve Lockout - BALL
	(Steel Powder coated.) Color: Red.
	Locks Valve Sizes: 32 - 76 mm.
Size: 32 - 76 mm.	
Brand:	Origin: China
Weight:	Packaging:



Model No.:	VL-BV-625PVC
Description:	Valve Lockout - BALL
	(Steel Powder coated.) Color: Red.
	Two Piece PVC.
Size: 6 - 25 mm.	
Brand:	Origin: China
Weight:	Packaging:



Model No.:	VL-BV-HNDL
Description:	Valve Lockout - BALL Type, Seal Tight
	Handle-Off bag. Color: Red.
Bag Size: 324mm x 292 mm. Lock Diameter: 8mm	
Brand:	Origin: China
Weight:	Packaging: 01 No.

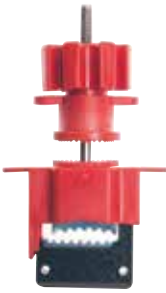

VALVE LOCKOUTS

Model No.:	VL-UNAC41-1
Description:	Valve Lockout - UNIVERSAL
	Base Only. Fits upto 40mm width, 19mm thk. handles.
Locks Lever size: Width 40mm x Thk. 19 mm.	
Brand: LOQ-IT	Origin: China
Weight:	Packaging:
	

Model No.:	VL-UNAC41-2
Description:	Valve Lockout - UNIVERSAL
	Base + 2.0 mtrs. cable. Fits upto 40mm width, 19mm thk. handles.
Locks Lever size: Width 40mm x Thk. 19 mm.	
Brand: LOQ-IT	Origin: China
Weight:	Packaging:
	

Model No.:	VL-UNAC41-3
Description:	Valve Lockout - UNIVERSAL
	Base + 1 Arm. Fits upto 40mm width, 19mm thk. handles.
Locks Lever size: Width 40mm x Thk. 19 mm.	
Brand: LOQ-IT	Origin: China
Weight:	Packaging:
	

Model No.:	VL-UNAC41-4
Description:	Valve Lockout - UNIVERSAL
	Base + Cable + 1 Arm. Fits upto 40mm width, 19mm thk. handles
Locks Lever size: Width 40mm x Thk. 19 mm.	
Brand: LOQ-IT	Origin: China
Weight:	Packaging:
	

Model No.:	VL-UNAC41-5
Description:	Valve Lockout - UNIVERSAL
	Base + 2 Arms. Fits upto 40mm width, 19mm thk. handles.
Locks Lever size: Width 40mm x Thk. 19 mm.	
Brand: LOQ-IT	Origin: China
Weight:	Packaging:
	

Model No.:	VL-UNAC41-6
Description:	Valve Lockout - UNIVERSAL
	Base + Cable + 2 Arms. Fits upto 40mm width, 19mm thk. handles.
Locks Lever size: Width 40mm x Thk. 19 mm.	
Brand: LOQ-IT	Origin: China
Weight:	Packaging:
	

Model No.:	VL-41-ARM
Description:	Blocking Arm for Universal Valve Lockout.
	Polypropylene materials, Color: Red.
Size:	Dimensions:
Brand:	Origin: China
Weight:	Packaging:
	

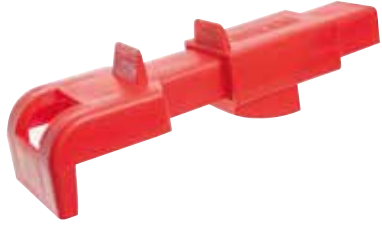
Model No.:	VL-BF-LEV
Description:	Valve Lockout - Butterfly
	construction, Locks Spring type Lever handle butterfly valves. Color: Red.
Size: Standard	Dimensions:
Brand: LOTO-LOK®	Origin: China
Weight:	Packaging:
	

Model No.:	VL-BF-SAN
Description:	Valve Lockout - Sanitary Butterfly
	Suitable for locking round handle sanitary valves. Locks 5mm - 25mm handle dia.
Size: 5 - 25 mm.	Dimensions:
Brand:	Origin: China
Weight:	Packaging:
	

BUTTERFLY & PLUG VALVE LOCKOUTS

Model No.:	VL-PVLO
Description:	Valve Lockout - Plug
	Locking range: 10~34mm rectangular valve stem; 15~50mm round valve stem.
Size:	
Brand:	Origin: China
Weight:	Packaging:
	

Model No.:	VL-BF-2P
Description:	Valve Lockout - Butterfly Valve
	Lockout Device + Cable Lockout.
	Suitable for locking out Spring type
Lever handle	0.8~4.5cm butterfly valves. Size: 0.8~4.5cm.
Brand:	Origin: China
Weight:	Packaging:
	

Model No.:	VL-BF-1P
Description:	Valve Lockout - Butterfly Valve
	Lockout Device Only (without Cable Lockout).
	Suitable for locking out Spring type
Lever handle	0.8~4.5cm butterfly valves. Size: 0.8~4.5cm.
Brand:	Origin: China
Weight:	Packaging:
	

FLANGE LOCKOUTS

Model No.:	FL-SM-1319
Description:	Flange Lockout - Aluminium alloy & hardened steel, suitable for blocking nuts on blind flanges, prevents unauthorized flange removal. Color: Red.
Size:	Locks nuts between 13 - 19mm
Brand: LOQ-IT	Origin: China
Weight:	Packaging: 01 No.
	

Model No.:	FL-MD-2332
Description:	Flange Lockout - Aluminium alloy & hardened steel, suitable for blocking nuts on blind flanges, prevents unauthorized flange removal. Color: Red.
Size:	Locks nuts between 23 - 32mm
Brand: LOQ-IT	Origin: China
Weight:	Packaging: 01 No.
	

Model No.:	FL-LG-3548
Description:	Flange Lockout - Aluminium alloy & hardened steel, suitable for blocking nuts on blind flanges, prevents unauthorized flange removal. Color: Red.
Size:	Locks nuts between 35 - 48mm
Brand: LOQ-IT	Origin: China
Weight:	Packaging: 01 No.
	

CIRCUIT BREAKER LOCKOUTS (MCB & MCCB)

Model No.:	CB-PI-CTBL
Description:	Circuit Breaker Locking Device
	PIN-IN for Single Pole MCB's.
	Color: Green.
Brand: LOTO-LOK®	Origin: China
Weight:	Packaging:



Model No.:	CB-PO-CTBL
Description:	Circuit Breaker Locking Device
	PIN-OUT for Single & Multipole MCB's.
	Color: Yellow.
Brand: LOTO-LOK®	Origin: China
Weight:	Packaging:



Model No.:	CB-POW-CTBL
Description:	Circuit Breaker Locking Device
	PIN-OUT- WIDE for Single & Multipole MCB's.
	Color: Blue
Brand: LOTO-LOK®	Origin: China
Weight:	Packaging:



Model No.:	CB-COMBO-CTBL
Description:	Circuit Breaker Locking Device - Pin Combo (SET OF 3) for Miniature Circuit Breaker. 1 off PIN - IN, 1 off PIN - OUT, & 1 off PIN - OUT - WIDE.
Brand: LOTO-LOK®	Origin: China
Weight:	Packaging:



Model No.:	CB-MG-CTBL
Description:	Circuit Breaker Locking Device - for Single & Multi Pole MCB's & MCCB's. Opened & closed with Screwdriver. Color: Yellow.
Brand: LOTO-LOK®	Origin: China
Weight:	Packaging:



Model No.:	CB-POL-Y
Description:	Circuit Breaker Locking Device
	PIN-OUT for Single & Multipole MCB's with LATCH. Color: Yellow
Brand: LOTO-LOK®	Origin: China
Weight:	Packaging:



Model No.:	CB-AB-CTBL
Description:	Circuit Breaker Locking Device - for Single & Multi Pole MCB's & MCCB's. Opened & closed with Screwdriver. Color: Blue.
Brand: LOTO-LOK®	Origin: China
Weight:	Packaging:



Model No.:	CB-FLRD
Description:	Circuit Breaker / Fuse lockout
	Screwdriver Required, Color: Red.
Brand:	Origin: China
Weight:	Packaging:



Model No.:	CB-UB-CTBL
Description:	Circuit Breaker Locking Device
	for Single Pole MCB's. Opened & closed with screwdriver. Color - Red.
Brand: LOTO-LOK®	Origin: China
Weight:	Packaging:



CIRCUIT BREAKER LOCKOUTS (MCB & MCCB)

Model No.:	CB-UNI-HT
Description:	Circuit Breaker Locking Device,
	Universal type for Single & Multipole MCB's & MCCB's upto 200A.
	Hand Tightening. NO-TOOL. Color: Red.
Brand: LOQ-IT	Origin: China
Weight:	Packaging:



Model No.:	CB-UNI-DTHT
Description:	Circuit Breaker Locking Device
	Universal type with Dove Tail for locking a wide range of MCCB's up to 200 Amps.
	Hand Tightening. NO-TOOL. Color: Red.
Brand: LOQ-IT	Origin: China
Weight:	Packaging:



Model No.:	CB-COV94
Description:	Circuit Breaker Locking Device - Universal
	type for Single & Multipole MCB's & MCCB's upto 200A with cover and 2 way padlocking slots. NO-TOOL. Color: Red.
Brand:	Origin: China
Weight:	Packaging:



Model No.:	CB-UNIHT-4ST
Description:	Circuit Breaker Locking Device
	Universal type for Multipole MCB & MCCB,
	Hand Tightening. NO-TOOL. Color: Red.
Brand: LOQ-IT	Origin: China
Weight:	Packaging:



Model No.:	CB-UNIDTHT-4ST
Description:	Circuit Breaker Locking Device
	Universal type for MCCB's. Hand Tightening. NO-TOOL. Color: Red.
Brand: LOQ-IT	Origin: China
Weight:	Packaging:



Model No.:	STL-CTBL
Description:	Circuit Breaker Locking Device -
	for Schneider MCCB's with multiple padlocking facility. Steel construction.
Brand:	Origin: China
Weight:	Packaging:



Model No.:	CB-TB
Description:	Circuit Breaker Locking Device -
	Tie Bar for Multi Pole MCB's.
	Color - Red.
Brand: LOTO-LOK®	Origin: China
Weight:	Packaging:



Model No.:	CB-UMPBL
Description:	Circuit Breaker Locking Device -
	Universal Multi Pole Circuit Breaker Lockout. Color: Red.
Brand: LOTO-LOK®	Origin: China
Weight:	Packaging:



Model No.:	CB-CLO
Description:	Circuit Breaker Locking Device
	Clamp on, Pin type for MCCB toggles with holes. Color: Red.
Brand: LOTO-LOK®	Origin: China
Weight:	Packaging:



CIRCUIT BREAKER LOCKOUTS (MCB & MCCB)

Model No.:	LSP - COMBO - 5SET
Description:	Circuit Breaker Locking Device
	Combo Circuit Breaker Lockout. Set of 5 Pcs.
Brand: LOTO-LOK®	Origin: China
Weight:	Packaging:



Model No.:	CB-BT-CTBL
Description:	Circuit Breaker Locking Device
	for MCCB's with Large Toggles upto 600 AMPS. Color: Red.
Brand: LOTO-LOK®	Origin: China
Weight:	Packaging:



Model No.:	CB-DUO-CTBL
Description:	Circuit Breaker Locking Device
	for MCB's & MCCB's. Accomodates different toggle sizes. Color: Red
Brand:	Origin: China
Weight:	Packaging:



Model No.:	CB-KT-S
Description:	Circuit Breaker Locking Device
	locks outs 277 Volts MCCB's with toggle widths 16mm x Thk. 11.5 mm.
Thumbwheel operation. Color: Red. Size: Small.	
Brand: LOQ-IT	Origin: China
Weight:	Packaging:



Model No.:	CB-KT-M
Description:	Circuit Breaker Locking Device
	locks outs 480/600Volts MCCB's with toggle widths 41mm x Thk. 13.5 mm.
Thumbwheel operation. Color: Red. Size: Medium.	
Brand: LOQ-IT	Origin: China
Weight:	Packaging:



Model No.:	CB-KT-L
Description:	Circuit Breaker Locking Device
	locks outs 480/600Volts MCCB's with Oversized toggle widths
	63mm x Thk. 22 mm. Thumbwheel operation. Color: Red. Size: Large.
Brand: LOQ-IT	Origin: China
Weight:	Packaging:



Model No.:	CB-LCB-RH
Description:	Circuit Breaker Locking Device -
	for MCCB with large toggles upto 600Amps. Round handle. NO-TOOL required. Accommodates multiple padlocks.
Brand:	Origin: China
Weight:	Packaging:



Model No.:	CB-LCB-HT
Description:	Circuit Breaker Locking Device - for MCCB
	with large toggles upto 600Amps. NO-TOOL required. Tightens by hand.
Brand:	Origin: China
Weight:	Packaging:





Model No.:	CB-MCB-S
Description:	Circuit Breaker Locking Device to lock
	MCB upto 49 mm body length. Nylon body with aluminium jaws.
Ideal for blocking MCB's. Color: Red	
Dimensions: Inner Lgth 49mm x Inner Width 30mm	
Brand: LOTO-LOK®	Origin: China
Weight:	Packaging: 01 No.

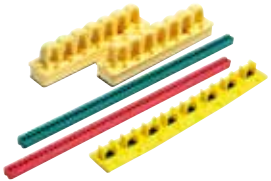

CIRCUIT BREAKER LOCKOUTS (MCB & MCCB)

Model No.:	CB-MCB
Description:	Circuit Breaker Locking Device to lock MCB upto 61 mm body length.
	Nylon body with aluminium jaws.
Ideal for blocking MCB's. Color: Red	
Dimensions: Inner Lgth 61mm x Inner Width 40mm	
Brand: LOTO-LOK®	Origin: China
Weight:	Packaging: 01 No.
	

Model No.:	CB-BBK-5
Description:	Circuit Breaker Locking Device locks out 600A MCCB's with Oversized toggles. (Break Blocker Components)
	480v~600v. Set consists of 2 self adhesive bases, 1 Red & 1 Green blocking bars and 1 self adhesive bar holder.
Brand:	Origin: China
Weight:	Packaging:
	

Model No.:	CB-MST-4093
Description:	Circuit Breaker Locking Device for MCCB's with small toggles.
	Color: Red. Size: Small.
Brand:	Origin: China
Weight:	Packaging:
	

Model No.:	CB-MST-4091
Description:	Circuit Breaker Locking Device for MCCB's with tall and wider Toggles.
	Color: Red. Size: Large.
Brand:	Origin: China
Weight:	Packaging:
	

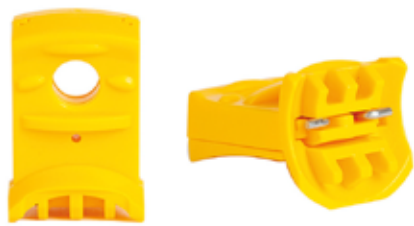
Model No.:	CB-SCNH-PO
Description:	Circuit Breaker Locking Device for PIN type single & multipole MCB's.
	Material: Nylon PA. Color: Yellow.
Brand:	Origin: China
Weight:	Packaging:
	

Model No.:	CB-DP-CTBL
Description:	Circuit Breaker Locking Device Locks 2 pole MCB's.
	Color: Red.
Brand:	Origin: China
Weight:	Packaging:
	

Model No.:	CB-SP-CTBL
Description:	Circuit Breaker Locking Device Locks Single Pole MCB's.
	Color: Red.
Brand:	Origin: China
Weight:	Packaging:
	

Model No.:	CB-MP-CTBL
Description:	Circuit Breaker Locking Device Locks Single Pole MCB's.
	Color: Red.
Brand:	Origin: China
Weight:	Packaging:
	

Model No.:	CB-TG-CTBL
Description:	Circuit Breaker Locking Device Locks 2 pole MCB's.
	Color: Red.
Brand:	Origin: China
Weight:	Packaging:
	

PANEL & PUSH BUTTON LOCKOUTS

Model No.:	PL-CIR-45
Description:	Panel Lockout - Push Button
	Polycarbonate material. Transparent.
	Circular Base 45mm Diameter.
Size: 45mm Dia.	Dimensions:
Brand: LOTO-LOK®	Origin: China
Weight:	Packaging:

Base permanently mounts on Panel with double sided tape.

Model No.:	PL-CIR-55
Description:	Panel Lockout - Push Button
	Polycarbonate material. Transparent.
	Circular Base 55mm Diameter.
Size: 55mm Dia.	Dimensions:
Brand: LOTO-LOK®	Origin: China
Weight:	Packaging:

Base permanently mounts on Panel with double sided tape.

Model No.:	PL-SQS-50
Description:	Panel Lockout - Push Button / Switch
	Polycarbonate material. Transparent.
	Inner Size: 58 x 58 mm.
Size: 58 x 58mm	Dimensions:
Brand: LOTO-LOK®	Origin: China
Weight:	Packaging:

Base permanently mounts on Panel with double sided tape.

Model No.:	PL-SQB-75
Description:	Panel Lockout - Push Button / Switch
	Polycarbonate material. Transparent.
	Inner Size: 58mm Height x 75mm Width.
Size: H 58 x W 75 mm.	Dimensions:
Brand: LOTO-LOK®	Origin: China
Weight:	Packaging:

Base permanently mounts on Panel with double sided tape.

Model No.:	PL-SQB-90
Description:	Panel Lockout - Push Button / Switch
	Acrylic material. Transparent.
Inner Size: 80mm Length x 80mm Width x 58mm Depth.	
Brand: LOTO-LOK®	Origin: India
Weight:	Packaging: 01 No.

Base permanently mounts on Panel with double sided tape.

Model No.:	PL-EPB-90
Description:	Panel Lockout - Push Button Emergency
	Polycarbonate material. Transparent.
	30mm I.D. Base X 70mm Internal I.D.
Size: 30 x 70mm	Dimensions:
Brand: LOTO-LOK®	Origin: China
Weight:	Packaging:

Removable Device. Non-permanent.

Model No.:	PL-BT-22
Description:	Panel Lockout - Push Button
	Polycarbonate material. Transparent.
	Accommodates upto 22mm dia Base.
Size: 22mm I.D.	Dimensions:
Brand: LOTO-LOK®	Origin: China
Weight:	Packaging:

Device mounts permanently on Base of Push Button.

Model No.:	PL-BT-30
Description:	Panel Lockout - Push Button
	Polycarbonate material. Transparent.
	Accommodates upto 30mm dia Buttons.
Size: 30mm I.D.	Dimensions:
Brand: LOTO-LOK®	Origin: China
Weight:	Packaging:

Device mounts permanently on Base of Push Button.

Model No.:	PL-CB-22E53
Description:	Panel Lockout - Push Button
	Polycarbonate material. Transparent.
	Accommodates 22mm dia Buttons.
Size: 22 mm.	Dimensions:
Brand:	Origin: China
Weight:	Packaging:

Collar mounts permanently on Base of Push Button - Cover is removable.

PANEL & PUSH BUTTON LOCKOUTS

Model No.:	PL-CB-30E53
Description:	Panel Lockout - Push Button
	Polycarbonate material. Transparent.
	Accommodates 30mm dia Buttons.
Size: 30 mm.	Dimensions:
Brand:	Origin: China
Weight:	Packaging:

Collar mounts permanently on Base of Push Button - Cover is removable.



Model No.:	PL-RC-22
Description:	Panel Lockout - Push Button
	Polycarbonate material. Clear/Red.
	Accommodates 22mm dia Buttons.
Size: 22 mm.	Dimensions:
Brand:	Origin: China
Weight:	Packaging:

Device mounts permanently on Base of Push Button.



Model No.:	PL-RC-30
Description:	Panel Lockout - Push Button
	Polycarbonate material. Clear/Red.
	Accommodates 30mm dia Buttons.
Size: 30 mm.	Dimensions:
Brand:	Origin: China
Weight:	Packaging:

Device mounts permanently on Base of Push Button.



Model No.:	PL-AD-2732
Description:	Panel Lockout - Push Button Adjustable
	Fits 27~32mm diameter push buttons and round switch knobs.
Size: 62 x 54mm Dia.	Dimensions:
Brand:	Origin: China
Weight:	Packaging:

Removable Device. Non-permanent. Ideal for locking push buttons where the base cannot be removed.



FUSE LOCKOUTS

Model No.:	FL-BR-FW
Description:	Fuse Lockout - Four Way.
	Fits fuses 1/4", 9/32", 13/32" & 9/16" in size. Color: Red.
Size:	
Brand:	Origin: China
Weight:	Packaging:
	

Model No.:	FL-BR-TW
Description:	Fuse Lockout - Two Way
	Fits fuses 13/16", 11/16" & blade type fuses. Color: Red.
Size:	
Brand:	Origin: China
Weight:	Packaging:
	

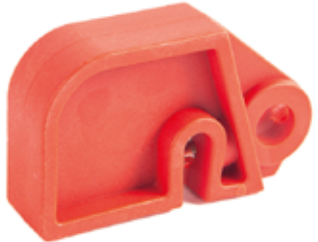
Model No.:	CB-FLRD
Description:	Circuit Breaker / Fuse lockout
	Screwdriver Required, Color: Red.
Size:	
Brand:	Origin: China
Weight:	Packaging:
	

WALL SWITCH LOCKOUTS

Model No.:	WSL-RD-MST
Description:	Wall Switch Lockout
	Color: Red.
Dimensions:	
Brand:	Origin: China
Weight:	Packaging:
	

Model No.:	WSL-443
Description:	Wall Switch Lockout
	Polycarbonate Lockable Single Switch Electrical Socket Covers.
Dimensions: 99.92 mm x 99.52 mm x 64.72 mm.	
Brand: LOTO-LOK®	Origin: China
Weight:	Packaging:
	

Model No.:	WSL-643
Description:	Wall Switch Lockout
	Polycarbonate Lockable Dual Switch Electrical Socket Covers.
Dimensions: 158.32 mm x 98.04 mm x 64.71 mm.	
Brand: LOTO-LOK®	Origin: China
Weight:	Packaging:
	

PNEUMATIC COUPLER LOCKOUTS

Model No.:	PNL-SS-612
Description:	Pneumatic Lockout - Stainless Steel
	Locks Male Connector sizes: 1/4", 3/8" & 1/2".
Dimensions: 1/4", 3/8" & 1/2".	
Brand:	Origin: China
Weight:	Packaging:



Model No.:	PNL-PLRD-612
Description:	Pneumatic Lockout - Nylon 3 Way.
	Locks Male Connector sizes: 1/4", 3/8" & 1/2". Color : Red.
Dimensions: 1/4", 3/8" & 1/2".	
Brand:	Origin: China
Weight:	Packaging:



CYLINDER, PLUG & PENDANT LOCKOUTS

Model No.:	PLG-RPL-Y
Description:	Plug Lockout - Electrical.
	Round, Color: Yellow
	Size: W 126 x L 160 x Ø 103mm.
Dimensions: 126 x 160 x Ø 103mm.	
Brand:	Origin: China
Weight:	Packaging:
	

Model No.:	PLG-RPL-R
Description:	Plug Lockout - Electrical.
	Round, Color: Red.
	Size: W 126 x L 160 x Ø 103mm.
Dimensions: 126 x 160 x Ø 103mm.	
Brand:	Origin: China
Weight:	Packaging:
	

Model No.:	PLG-LRPM
Description:	Plug Lockout - Electrical.
	Locks small & medium sized electrical plugs. Color: Red.
Dimensions: 65 x 65 x 118mm.	
Brand:	Origin: China
Weight:	Packaging:
	

Model No.:	PLG-LRPL
Description:	Plug Lockout - Electrical.
	Locks Large size electrical plugs.
	Color: Red.
Dimensions: 83 x 83 x 178mm.	
Brand:	Origin: China
Weight:	Packaging:
	

Model No.:	PLG-EP4H
Description:	Plug Lockout - Electrical / Pneumatic.
	Locks electrical plugs & pneumatic fittings. Color: Red.
Dimensions: 97 x 95 x 170mm.	
Brand:	Origin: China
Weight:	Packaging:
	

Model No.:	PLG-RND-SM
Description:	Plug Lockout - Rotating housing. Ideal for locking small electrical 2 or 3 pin plugs. Color: Red.
Dimensions: W 58 x H 95mm.	
Brand: LOTO-LOK®	Origin: China.
Weight:	Packaging: 01 No.
	

Model No.:	PLG-RND-LG
Description:	Plug Lockout - Rotating housing. Ideal for locking medium sized electrical sized plugs. Color: Red.
Dimensions: W 78 x H 169mm.	
Brand: LOTO-LOK®	Origin: China.
Weight:	Packaging: 01 No.
	

Model No.:	PNDT-9X9
Description:	Pendant & Plug Lockout.
	Color: Red. Size: Small.
	Lockouts Large Plugs & Small Pendants.
Dimensions: W9" x H9"	
Brand: LOTO-LOK®	Origin: India
Weight:	Packaging:
	

Model No.:	PNDT-9X12
Description:	Pendant & Plug Lockout.
	Color: Red. Size: Medium. Lockouts Extra Large Plugs & Small Pendants.
Dimensions: W9" x H12"	
Brand: LOTO-LOK®	Origin: India
Weight:	Packaging:
	

CYLINDER, PLUG & PENDANT LOCKOUTS

Model No.:	PNDT-9X18
Description:	Pendant & Plug Lockout.
	Color: Red. Size: Large.
	Lockouts Medium Pendants.
Dimensions:	W9" x H18"
Brand: LOTO-LOK®	Origin: India
Weight:	Packaging:



Model No.:	PNDT-9X26
Description:	Pendant & Plug Lockout.
	Color: Red. Size: Extra Large.
	Lockouts Large Pendants.
Dimensions:	W9" x H26"
Brand: LOTO-LOK®	Origin: India
Weight:	Packaging:



SPECIAL APPLICATION LOCKOUTS

Model No.:	MPD-YBPL-26
Description:	Switch Lockout Device – Panel Lockout with Adhesive Base. Color: Yellow.
	Locks knob switch & change over switch.
Size:	
Brand:	Origin: China
Weight:	Packaging:
Adhesive Base	
	

Model No.:	MPD-YBPL-27
Description:	Switch Lockout Device – Panel Lockout with Adhesive Base. Color: Yellow.
	Locks Push buttons & Covers Key Holes.
Size:	
Brand:	Origin: China
Weight:	Packaging:
Adhesive Base	
	

Model No.:	MPD-YBPL-28
Description:	Switch Lockout Device – Panel Lockout with Adhesive Base. Color: Yellow.
	Immobilises cabinet doors & Covers Key Holes.
Size:	
Brand:	Origin: China
Weight:	Packaging:
Adhesive Base	
	

Model No.:	MPD-YBPL-29
Description:	Switch Lockout Device – Panel Lockout with Adhesive Base. Color: Yellow.
	Lock switch handles & change over switch.
Size:	
Brand:	Origin: China
Weight:	Packaging:
Adhesive Base	
	

Model No.:	MPD-YBPL-30
Description:	Switch Lockout Device – Panel Lockout with Adhesive Base. Color: Yellow.
	Lock knife switches & Isolator handles.
Size:	
Brand:	Origin: China
Weight:	Packaging:
Adhesive Base	
	

CAR SEALS, TAGS & DISCS

Model No.:	CS-RED-1M
Description:	Car Seals - Aluminium / Zinc Body, Galvanized
	wire cable 1 mtr. Long, Self-Locking with Unique Serial No. printed on each piece. Color: Red.
Size: 2.5mm wire dia x 1mtr Length	
Brand: LOTO-LOK®	Origin: China
Weight:	Packaging:
	

Model No.:	CS-GRN-1M
Description:	Car Seals - Aluminium / Zinc Body, Galvanized
	Aircraft wire cable 1 mtr. Long, Self-Locking with Unique Serial No. printed on each piece. Color: Green.
Size: 2.5mm wire dia x 1mtr Length	
Brand: LOTO-LOK®	Origin: China
Weight:	Packaging:
	

Model No.:	CS-GRY-1M
Description:	Car Seals - Aluminium / Zinc Body, Galvanized
	Aircraft wire cable 1 mtr. Long, Self-Locking with Unique Serial No. printed on each piece. Color: Grey.
Size: 2.5mm wire dia x 1mtr Length	
Brand: LOTO-LOK®	Origin: China
Weight:	Packaging:
	

Model No.:	CS-BLU-1M
Description:	Car Seals - Aluminium / Zinc Body, Galvanized
	Aircraft wire cable 1 mtr. Long, Self-Locking with Unique Serial No. printed on each piece. Color: Blue.
Size: 2.5mm wire dia x 1mtr Length	
Brand: LOTO-LOK®	Origin: China
Weight:	Packaging:
	

Model No.:	CS-BLK-1M
Description:	Car Seals - Aluminium / Zinc Body, Galvanized Aircraft
	wire cable 1 mtr. Long, Self-Locking with Unique Serial No. printed on each piece. Color: Black.
Size: 2.5mm wire dia x 1mtr Length	
Brand: LOTO-LOK®	Origin: China
Weight:	Packaging:
	

Model No.:	CST-VLVC-R
Description:	Disc - "VALVE LOCKED CLOSED".
	Material: Stainless Steel 316. With 190 mm. Long stainless-steel wire. Color: Red
Size: 40mm Dia.	Thickness: 1 mm.
Brand:	Origin: China
Weight:	Packaging:
	

Model No.:	CST-VLVO-G
Description:	Disc - "VALVE LOCKED OPEN".
	Material: Stainless Steel 316. With 190 mm. Long stainless-steel wire. Color: Green.
Size: 40mm Dia.	Thickness: 1 mm.
Brand:	Origin: China
Weight:	Packaging:
	

Model No.:	TAGD-CSR
Description:	Tag - "CAR SEAL CLOSED". Color: Red.
	PVC Sheet with one side printing with Metal OR Punched Eyelet.
Size: W80mm x L160mm x Thk.0.5mm	
Brand:	Origin: China
Weight:	Packaging:
	

Model No.:	TAGD-CSG
Description:	Tag - "CAR SEAL OPEN". Color: Green.
	PVC Sheet with one side printing with Metal OR Punched Eyelet.
Size: W80mm x L160mm x Thk.0.5mm	
Brand:	Origin: China
Weight:	Packaging:
	

PIN & SLEEVE LOCKOUTS

Model No.:	PSL-S40
Description:	Pin & Sleeve Industrial socket lockout
	diameter 40mm, suitable for locking Small size sockets.
Size: 40mm dia.	
Brand:	Origin: China
Weight:	Packaging:
	

Model No.:	PSL-M44
Description:	Pin & Sleeve Industrial socket lockout
	diameter 44mm, suitable for locking Medium size sockets.
Size: 44mm dia.	
Brand:	Origin: China
Weight:	Packaging:
	

Model No.:	PSL-L50
Description:	Pin & Sleeve Industrial socket lockout
	diameter 50mm, suitable for locking Large size sockets.
Size: 50mm dia.	
Brand:	Origin: China
Weight:	Packaging:
	

Model No.:	PSL-XL63
Description:	Pin & Sleeve Industrial socket lockout
	diameter 63mm, suitable for locking Extra Large size sockets.
Size: 63mm dia.	
Brand:	Origin: China
Weight:	Packaging:
	

Model No.:	PSL-XL73
Description:	Pin & Sleeve Industrial socket lockout
	diameter 73mm, suitable for locking Extra Large size sockets.
Size: 73mm dia.	
Brand:	Origin: China
Weight:	Packaging:
	

LOTO STATIONS

Model No.:	LS-7L2P-Y
Description:	Lockout Station - Molded Plastic, durable & unbreakable. Configuration: 7 Hooks for Padlocks + 2 Tag Pockets (upto 10 Tags per pocket) + 2 Hooks (can store upto 2 Hasps per hook). Empty Station Only. Color: Yellow
Dimensions:	L300 x W400 mm.
Brand: LOTO-LOK®	Origin: China
Weight:	Packaging:



Model No.:	LS-7L2P-Y-CS
Description:	Lockout Station - Molded Plastic, durable & unbreakable. 7 Padlocks + 20 Tags + Cable Ties + Marker Pen + 2 Hasps. Complete Station with contents. Color: Yellow.
Dimensions:	L300 x W400 mm.
Brand: LOTO-LOK®	Origin: China
Weight:	Packaging:



Model No.:	LS-16L-1P-Y
Description:	Lockout Station - Molded Plastic, durable & unbreakable. Configuration: 16 Hooks for Padlocks + 1 Tag Pocket (upto 10 Tags) + 2 Hooks (can store upto 2 Hasps per hook). Empty Station Only. Color: Yellow.
Dimensions:	L350 x W360 mm.
Brand: LOTO-LOK®	Origin: China
Weight:	Packaging:



Model No.:	LS-16L-1P-Y-CS
Description:	Lockout Station - Molded Plastic, durable & unbreakable. 16 Padlocks + 10 Tags + Cable Ties + Marker Pen + 2 Hasps. Complete Station with contents. Color: Yellow.
Dimensions:	L350 x W360 mm.
Brand: LOTO-LOK®	Origin: China
Weight:	Packaging:



Model No.:	LS-ACST-24L2P-EB
Description:	Lockout Station - Heavy duty acrylic ideal for stocking Padlocks, Tags & Hasps. Configuration: 24 Hooks for Padlocks + 2 Tag Pockets (10 tags per pocket) + 2 Hooks (can store upto 2 Hasps per hook). Empty Station Only. Color: Yellow.
Dimensions:	L507 x W409 mm.
Brand: LOTO-LOK®	Origin: China
Weight:	Packaging:



Model No.:	LS-ACST-24L2P-CS
Description:	Lockout Station - Heavy duty acrylic construction, ideal for hanging Padlocks & Hasps. Clear pockets for Tags. 24 Padlocks + 20 Tags + Cable Ties + Marker Pen + 2 Hasps. Complete Station with contents. Color: Yellow.
Dimensions:	L507 x W409 mm.
Brand: LOTO-LOK®	Origin: China
Weight:	Packaging:

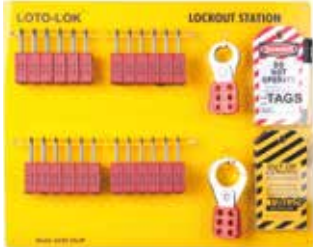

Model No.:	LS-ACST-48L4P-EB
Description:	Lockout Station - Heavy duty acrylic construction, ideal for stocking Padlocks, Tags & Hasps. Configuration: 48 Hooks for Padlocks + 4 Tag Pockets (10 Tags per pocket) + 2 Hooks (can store upto 2 Hasps per hook). Color: Yellow
Dimensions:	L685 x W604 mm.
Brand: LOTO-LOK®	Origin: China
Weight:	Packaging:

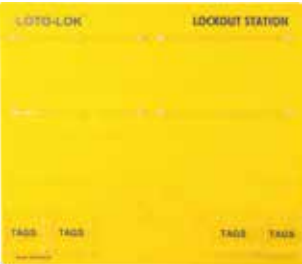



Model No.:	LS-ACST-48L4P-CS
Description:	Lockout Station - Heavy duty acrylic construction, ideal for hanging Padlocks & Hasps. Clear pockets for Tags. 48 Padlocks + 40 Tags + Cable Ties + Marker Pen + 4 Hasps. Complete Station with contents. Color: Yellow
Dimensions:	L685 x W604 mm.
Brand: LOTO-LOK®	Origin: China
Weight:	Packaging:



LOTO STATIONS

Model No.:	LS-MST04-EB
Description:	Lockout Station - Heavy duty molded plastic body with strong polycarbonate lockable cover.
	Ideal for stocking Padlocks, Hasps & Tags.
	Separate pocket stores Tags, Marker Pen & Cable Ties. Each hook can hang upto 2 Padlocks or Hasps. 5 Hooks + 1 Tag Pocket.
	Empty Station Only. Color: Yellow.
Dimensions: L320 x W420 x D70 mm.	
Brand:	Origin: China
Weight:	Packaging:
	

Model No.:	LS-MST04-CS
Description:	Lockout Station - Heavy duty molded plastic body with strong polycarbonate lockable cover.
	Ideal for stocking Padlocks & Hasps. Separate pocket stores Tags, Marker Pen & Cable Ties.
	Hooks are designed to hang 1 or 2 padlocks per hook. Can be customized to specific requirements.
	Complete Station with contents. Color: Yellow.
Dimensions: L320 x W420 x D70 mm.	
Brand:	Origin: China
Weight:	Packaging:
	

Model No.:	LS-MST10-EB
Description:	Lockout Station - Heavy duty molded plastic body with strong polycarbonate lockable cover.
	Ideal for stocking Padlocks, Hasps & Tags.
	Separate pocket stores Tags, Marker pen & Cable ties. Each hook can hang upto 2 Padlocks or Hasps. 15 Hooks + 2 Tag Pockets.
	Empty Station Only. Color: Yellow.
Dimensions: L400 x W560 x D70 mm.	
Brand:	Origin: China
Weight:	Packaging:
	

Model No.:	LS-MST10-CS
Description:	Lockout Station - Heavy duty molded plastic body with strong polycarbonate lockable cover.
	Ideal for stocking Padlocks & Hasps. Separate pocket stores Tags, Marker Pen & Cable Ties. Hooks are designed to hang 1 or 2 Padlocks per hook.
	Complete Station with contents.
	Color: Yellow.
Dimensions: L400 x W560 x D70 mm.	
Brand:	Origin: China
Weight:	Packaging:
	

Model No.:	LS-MST08P-EB	
Description:	Lockout Station - Polycarbonate w/cover. 8 Hooks to store Padlocks and Hasps (can store 2 padlocks / Hasps per hook) + bottom shelf to store Lockout / Tagout products.	
	Empty Station Only. Color: Yellow.	
	Dimensions: L574mm x W396mm x D108 mm.	
	Brand:	Origin: China
Weight:	Packaging:	
		

Model No.:	LS-SWC22H-4P
Description:	Lockout Station - Molded ABS + PC construction with locable door. Accommodate 20 Locks + 2 Hasps + 4 Tag Pockets.
	Color: Yellow. Station without contents.
Dimensions: L 625mm x W 590mm x D 97 mm.	
Brand: LOTO-LOK®	Origin: China.
Weight:	Packaging: 01 No.
	

Model No.:	LS-SWC22H-4P-CS
Description:	Lockout Station - Molded ABS + PC construction with locable door. 20 Padlocks, 2 Hasps, 40 Tags, Marker Pen & Cable Ties.
	Color: Yellow. Complete Station with contents.
Dimensions: L 625mm x W 590mm x D 97 mm.	
Brand: LOTO-LOK®	Origin: China.
Weight:	Packaging: 01 No.
	

Model No.:	LS-22H4PR
Description:	Lockout Station - Heavy duty Steel & powder coated construction with clear Acrylic Fascia. Accommodates 20 Locks + 2 Hasps + 4 Tag Pockets. Color: Red. Station without contents.
	Dimensions: 580mm x 430mm x 90mm.
Brand: LOTO-LOK®	Origin: China.
Weight:	Packaging: 01 No.
	

Model No.:	LS-22H4PR-CS
Description:	Lockout Station - Heavy duty Steel & powder coated construction with clear Acrylic Fascia. 20 Padlocks, 2 Hasps, 40 Tags, Marker Pen & Cable Ties. Color: Red. Complete Station with contents.
	Dimensions: 580mm x 430mm x 90mm.
Brand: LOTO-LOK®	Origin: China.
Weight:	Packaging: 01 No.
	

LOTO STATIONS

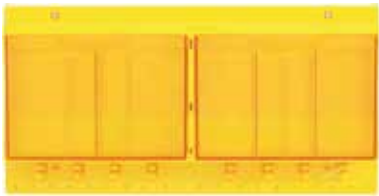
Model No.:	LS-MSTPT-EB
Description:	Lockout Station - Polycarbonate w/cover.
	8 Padlock Hooks and compartments to store Lockout / Tagout products.
	Color: Yellow. Empty Station Only.
Dimensions: L556mm x W280mm x D102 mm.	
Brand:	Origin: China
Weight:	Packaging:
	

Model No.:	LS-PRPPC-STN
Description:	Lockout Station - Polycarbonate construction w/cover.
	Portable + Wall hanging. Accomodate Padlocks + Tags or only Padlocks. Customizable.
	Color: Yellow. Station without contents.
Dimensions: L 408 mm x W 338 mm x D 98 mm	
Brand:	Origin: China.
Weight:	Packaging: 01 No.
	

Model No.:	LS-PRPPC-STN-CS
Description:	Lockout Station - Polycarbonate w/cover. Dual use & Adjustable, Portable + Wall hanging. Can be customized to accomodate padlocks + Tags or only Padlocks. Lockout / Tagout products.
	Color: Yellow. Station with contents.
	Dimensions: L 408 mm x W 338 mm x D 98 mm
Brand:	Origin: China
Weight:	Packaging:
	

Model No.:	LSM-6PD
Description:	Lockout Station - 6 Hooks for Padlocks / Hasps + 2 Tag Pockets and compartments to store LOTO products.
	Empty Station Only. Color: Yellow.
	Dimensions: L600 x W450 x D120 mm.
Brand: LOTO-LOK®	Origin: China
Weight:	Packaging:
	

Model No.:	LSM-10PD
Description:	Lockout Station - 10 Hooks for Padlocks / Hasps + 2 Tag Pockets and compartments to store LOTO products.
	Empty Station Only. Color: Yellow.
	Dimensions: L760 x W610 x D140 mm.
Brand: LOTO-LOK®	Origin: China
Weight:	Packaging:
	

Model No.:	LS-6CFY-EB
Description:	Lockout Station - Heavy duty steel construction, powder coated yellow, 2 adjustable shelves and door with clear acrylic fascia. Station is ideal for stocking a mix of Electrical & Mechanical LOTO Products. Empty Station Only. Color: Yellow.
	Dimensions: L360 x W450 x D155 mm.
	Brand: LOTO-LOK®
Weight:	Packaging:
	

Model No.:	LS-6STLY-EB
Description:	Lockout Station - Heavy duty steel construction, powder coated yellow, 2 adjustable shelves and Steel door. Station is ideal for stocking a mix of Electrical & Mechanical LOTO Products. Empty Station Only. Color: Yellow.
	Dimensions: L410 x W360 x D155 mm.
	Brand: LOTO-LOK®
Weight:	Packaging:
	

Model No.:	LS-10CFY
Description:	Lockout Station - Heavy duty steel construction, powder coated yellow, 2 adjustable shelves and door with clear acrylic fascia. Station is ideal for stocking a mix of Electrical & Mechanical LOTO Products. Empty Station Only. Color: Yellow.
	Dimensions: L600 x W550 x D250 mm.
	Brand: LOTO-LOK®
Weight:	Packaging:
	

Model No.:	LS-10STLY
Description:	Lockout Station - Heavy duty steel construction, powder coated yellow, 2 adjustable shelves and Steel door. Station is ideal for stocking a mix of Electrical & Mechanical LOTO Products. Empty Station Only. Color: Yellow.
	Dimensions: L600 x W550 x D250 mm.
	Brand: LOTO-LOK®
Weight:	Packaging:
	

LOTO STATIONS

Model No.:	LS-6CF-GLBY
Description:	Lockout Station - Clear Fascia with 2 adjustable shelves and Group Lock Box. Powder Coated Steel. Color: Yellow. Empty Box Only.
Dimensions: L 540 x W 360 x D 155 mm.	
Brand: LOTO-LOK®	Origin: China
Weight:	Packaging:
	

Model No.:	LS-STLY-9C-CF
Description:	Lockout Station - Heavy duty steel construction, powder coated yellow, 2 adjustable shelves, 5 Hooks for hanging Padlocks and door with clear acrylic fascia.
	Station is ideal for stocking a mix of Electrical & Mechanical LOTO Products.
	Empty Station Only. Color: Yellow.
Dimensions: L760 x W380 x D225 mm.	
Brand: LOTO-LOK®	Origin: India
Weight:	Packaging:
	

Model No.:	LS-STLR-9C-CF
Description:	Lockout Station - Heavy duty steel construction, powder coated red, 2 adjustable shelves, 5 Hooks for hanging Padlocks and door with clear acrylic fascia.
	Station is ideal for stocking a mix of Electrical & Mechanical LOTO Products.
	Empty Station Only. Color: Red.
Dimensions: L 765 x W 335 x D 235 mm.	
Brand: LOTO-LOK®	Origin: India
Weight:	Packaging:
	

Model No.:	LS-TRLY-MCY
Description:	Lockout Trolley - Portable, 2 wheels, 4 Compartments, for stocking various electrical & mechanical LOTO devices, Padlocks & Tags. Ideal & handy for shop floors
	where trolley can be wheeled on site. Reduces downtime.
Color: Yellow	
Dimensions: L 735 X W 490 X D 230 mm.	
Brand: LOTO-LOK®	Origin: China
Weight:	Packaging:
	

Model No.:	LTS-2S-PM-EB
Description:	Lockout Station - PP construction with handle. Portable + Wall mounting.
	Stores padlocks, devices & Tags.
Color: Yellow with lockable cover. Station without contents.	
Dimensions: L 430 x W 380 x H 150 mm.	
Brand:	Origin: China.
Weight:	Packaging: 01 No.
	

Model No.:	LS-8PTS
Description:	Tagout Station - 8 pockets. 8 clear acrylic pockets for accomodating tags upto 80mm width x 160mm length. Empty Station Only. Color: Yellow.
Dimensions: L 395 mm x W 445 mm.	
Brand: LOTO-LOK®	Origin: China
Weight:	Packaging:
	

LOTO STATIONS - SHADOW BOARDS

Model No.:	LS-SB6
Description:	Shadow Board - Aluminium frame.
	Cap: 6 Padlocks + 2 Hasps + 2 Tag Hooks. Empty Board Only.
Dimensions: L420 x W615 mm.	
Brand: LOTO-LOK®	Origin: China
Weight:	Packaging:



Model No.:	LS-SB6-CS
Description:	Shadow Board - Aluminium frame
	with 6 Padlocks + 2 Hasps + 20 Tags. Complete Station with contents.
Dimensions: L420 x W615 mm.	
Brand: LOTO-LOK®	Origin: China
Weight:	Packaging:



Model No.:	LS-SB12
Description:	Shadow Board - Aluminium frame.
	Cap: 12 Padlocks + 2 Hasps + 2 Tag Hooks. Empty Board Only.
Dimensions: L460 x W615 mm.	
Brand: LOTO-LOK®	Origin: China
Weight:	Packaging:



Model No.:	LS-SB12-CS
Description:	Shadow Board - Aluminium frame
	with 12 Padlocks + 2 Hasps + 20 Tags. Complete Station with contents.
Dimensions: L460 x W615 mm.	
Brand: LOTO-LOK®	Origin: China
Weight:	Packaging:



Model No.:	LS-SB24
Description:	Shadow Board - Aluminium frame.
	Cap: 24 Padlocks + 2 Hasps + 2 Tag Hooks. Empty Board Only.
Dimensions: L690 x W595 mm.	
Brand: LOTO-LOK®	Origin: China
Weight:	Packaging:



Model No.:	LS-SB24-CS
Description:	Shadow Board - Aluminium frame
	with 24 Padlocks + 2 Hasps + 20 Tags. Complete Station with contents.
Dimensions: L690 x W595 mm.	
Brand: LOTO-LOK®	Origin: China
Weight:	Packaging:



Model No.:	LS-SB36
Description:	Shadow Board - Aluminium frame.
	Cap: 36 Padlocks + 4 Hasps + 4 Tag Hooks. Empty Board Only.
Dimensions: L815 x W755 mm.	
Brand: LOTO-LOK®	Origin: China
Weight:	Packaging:



Model No.:	LS-SB36-CS
Description:	Shadow Board - Aluminium frame
	with 36 Padlocks + 4 Hasps + 40 Tags. Complete Station with contents.
Dimensions: L815 x W755 mm.	
Brand: LOTO-LOK®	Origin: China
Weight:	Packaging:





Model No.:	LS-SB50
Description:	Shadow Board - Aluminium frame.
	Cap: 50 Padlocks + 3 Hasps + 3 Tag Hooks. Empty Board Only.
Dimensions: L1000 x W735 mm.	
Brand: LOTO-LOK®	Origin: China
Weight:	Packaging:



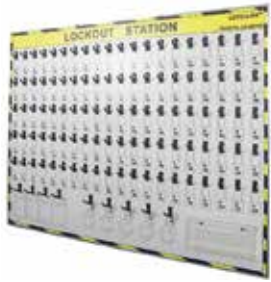

LOTO STATIONS - SHADOW BOARDS

Model No.:	LS-SB50-CS
Description:	Shadow Board - Aluminium frame
	with 50 Padlocks + 3 Hasps + 30 Tags. Complete Station with contents.
Dimensions: L1000 x W735 mm.	
Brand: LOTO-LOK®	Origin: China
Weight:	Packaging:
	

Model No.:	LS-SB100
Description:	Shadow Board - Aluminium frame.
	Cap: 100 Padlocks + 5 Hasps + 4 Tag
	Hooks. 1 Acrylic pocket for pens, clips & screwdrivers. Empty Board Only.
Dimensions: L1300 x W1005 mm.	
Brand: LOTO-LOK®	Origin: China
Weight:	Packaging:
	

Model No.:	LS-SB100-CS
Description:	Shadow Board - Aluminium frame with
	100 Padlocks + 5 Hasps + 40 Tags + Cable
	Ties + 1 Acrylic pocket for pens, clips & screwdrivers. Complete Station with contents.
Dimensions: L1300 x W1005 mm.	
Brand: LOTO-LOK®	Origin: China
Weight:	Packaging:
	

Model No.:	LS-SBEL
Description:	Shadow Board - Aluminium frame.
	Electrical Circuit Breaker Shadow Board.
	Cap: 4 Padlocks + 2 Hasps + 22 Circuit Breaker + 1 Tag Hook. Empty Board Only.
Dimensions: L450 x W600 mm.	
Brand: LOTO-LOK®	Origin: China
Weight:	Packaging:
	

Model No.:	LS-SBEL-CS
Description:	Shadow Board - Aluminium frame.
	Electrical Circuit Breaker Shadow Board
	with 4 Padlocks + 2 Hasps + 22 Circuit Breaker locking devices (various models) + 10 Tags. Complete Station with contents.
Dimensions: L450 x W600 mm.	
Brand: LOTO-LOK®	Origin: China
Weight:	Packaging:
	

Model No.:	LS-SBEM
Description:	Shadow Board - Electrical & Mechanical Shadow Board. Capacity: 8 Hooks for padlock + 10 Hooks for Hasp + 3 Hooks for Tag + 10 Hooks for Circuit Breaker Lockout + 3 Hooks for Cable Lockout + 5 Hooks for Gate Valve Lockout + 1 Acrylic Pocket. Empty Board Only.
Dimensions: L1220 x W840 mm.	
Brand: LOTO-LOK®	Origin: China
Weight:	Packaging:
	

Model No.:	LS-SBEM-CS
Description:	Shadow Board - Aluminium frame.
Electrical & Mechanical with 8 Padlocks + 10 Hasps + 30 Tags + 10 Circuit Breaker Lockout Devices + 3 Cable Lockouts + 5 Gate Valve Lockouts + 1 Acrylic Pocket (with cable ties, marker pen & screwdriver). Complete Station with content.	
Dimensions: L1220 x W840 mm.	
Brand: LOTO-LOK®	Origin: China
Weight:	Packaging:
	

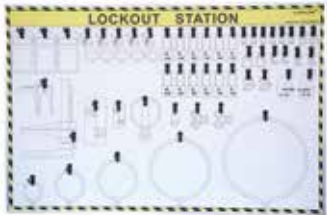
Model No.:	LS-SB-EMCM
Description:	Lockout Shadow Board Construction - PPC board with Aluminium alloy frame. Can be used for hanging a wide selection of Electrical & Mechanical Lockouts.
	Empty Station without contents.
Dimensions: H 800 mm x W 1220 mm.	
Brand: LOTO-LOK®	Origin: China
Weight:	Packaging:
	

Model No.:	LS-SB-EMCM-CS
Description:	Lockout Shadow Board Construction - PPC board with Aluminium alloy frame. Wide range of LOTO padlocks, Devices & Tags for Electrical & Mechanical Isolation.
	Complete Station with contents.
Dimensions: H 800 mm x W 1220 mm.	
Brand: LOTO-LOK®	Origin: China
Weight:	Packaging:
	

LOTO STATIONS - SHADOW BOARDS

Model No.:	LS-SB-EMGB
Description:	Lockout Shadow Board Construction – PPC board with Aluminium alloy frame. Accommodates a wide range of LOTO products
for Electrical & Mechanical Isolation. Molded plastic Group Lock	
Box 29 padlocks capacity can be installed. Inbuilt Acrylic Pocket.	
Station without contents.	
Dimensions: H 800 mm x W 1600 mm.	
Brand: LOTO-LOK®	Origin: China
Weight:	Packaging:

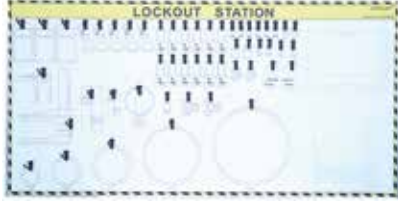

Model No.:	LS-SB-EMGB-CS
Description:	Lockout Shadow Board Construction – PPC board with Aluminium alloy frame. Wide range of LOTO products + Molded
Group Lock Box 29 padlocks capacity & Acrylic Pocket for	
Electrical & Mechanical Isolation. Complete Station with contents.	
Dimensions: H 800 mm x W 1600 mm.	
Brand: LOTO-LOK®	Origin: China
Weight:	Packaging:



Model No.:	LS-PTW-DH-CS
Description:	Lockout Shadow Board Construction – PPC board with Aluminium alloy frame, Upper part accommodates 3 yellow acrylic
PTW / Document holders with group locking facility,	
acrylic pocket at bottom stores documents. Complete Station.	
Dimensions: L 1200 x W 900 mm.	
Brand: LOTO-LOK®	Origin: India
Weight:	Packaging:



Model No.:	LS-SB-PHGLBY3
Description:	Shadow Board - Aluminium frame.
Group Lockout. Capacity: 3 Permit Holder + 3 Group Lockout Box + 24 Padlock + 3 Tag Hooks.	
Empty Board Only.	
Dimensions: L1220 x W1220 mm.	
Brand: LOTO-LOK®	Origin: India
Weight:	Packaging:

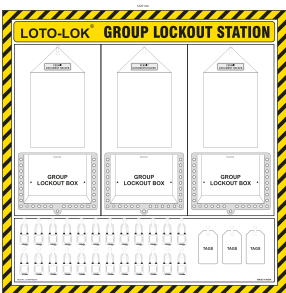

Model No.:	LS-SB-PHACP4
Description:	Shadow Board - Aluminium frame. Work Permit Station.
Capacity: 4 Permit Document Holder	
+ 4 Work Permit Holder Hooks. Empty Board Only.	
Dimensions: L1200 x H900 mm.	
Brand: LOTO-LOK®	Origin: India
Weight:	Packaging:

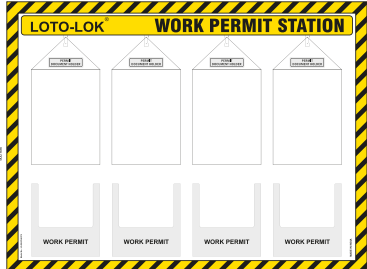

Model No.:	LS-SB-PHGLBR1
Description:	Shadow Board - Aluminium frame. Permit Control Board.
Capacity: 1 Permit Document Holder Hook + 1 Group Lockout Box Holder. Empty Board Only.	
Dimensions: L660 x W300 mm.	
Brand: LOTO-LOK®	Origin: India
Weight:	Packaging:

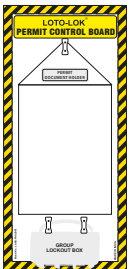

Model No.:	LS-SB-PHGLBY1
Description:	Shadow Board - Aluminium frame. Work Permit Station.
Capacity: 1 Permit Document Holder Hook + 1 Group Lockout Box Holder. Empty Board Only.	
Dimensions: L560 x W740 mm.	
Brand: LOTO-LOK®	Origin: India
Weight:	Packaging:

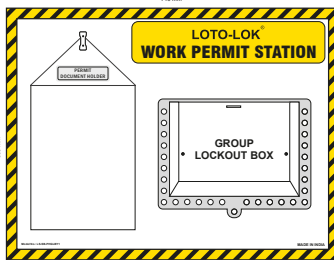

Model No.:	LS-SB-CLST4
Description:	Shadow Board - Aluminium frame. Cable Lockout Station Capacity: 4 Padlock + 2 Hasp + 1 Tag + 4 Cable Lockout Hooks.
Empty Board Only.	
Dimensions: L480 x W600 mm.	
Brand: LOTO-LOK®	Origin: India
Weight:	Packaging:

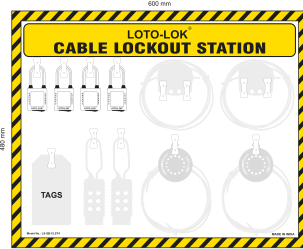

GROUP LOCKOUT STATIONS

Model No.:	GLB-SR13-TP
Description:	Group Lock Box - Steel, Powder coated RED color, accommodates 1 Primary & 12 secondary padlocks. Tag Pocket with
Chain holds 3 Tags for maintaining group locking details.	
Dimensions: L255 x W105 x H152mm.	
Brand: LOTO-LOK®	Origin: China
Weight:	Packaging:
	

Model No.:	GLB-SR13-NP
Description:	Group Lock Box - Steel, Powder coated RED color, accommodates 1 Primary & 12 secondary padlocks.
Dimensions: L255 x W105 x H152mm.	
Brand: LOTO-LOK®	Origin: China
Weight:	Packaging:
	

Model No.:	GLB-SR13B-NP
Description:	Group Lock Box - BIG (Portable), Red color powder coated, accommodates 1 Primary & 12 Secondary Padlocks.
Dimensions: 7.10" x 10" x 7.30"	
Brand: LOTO-LOK®	Origin: India
Weight:	Packaging: 01 No.
	

Model No.:	GLB-SY13-TP
Description:	Group Lock Box - Steel, Yellow color powder coated, accommodates 1 Primary & 12 Secondary Padlocks. Includes 3 Tags.
Dimensions: L 255 x W105 x H152mm.	
Brand: LOTO-LOK®	Origin: China
Weight:	Packaging:
	

Model No.:	GLB-SY13-NP
Description:	Group Lock Box - Steel, Yellow color powder coated, accommodates 1 Primary & 12 Secondary Padlocks. Includes 3 Tags.
Dimensions: L 255 x W105 x H152mm.	
Brand: LOTO-LOK®	Origin: China
Weight:	Packaging:
	

Model No.:	GLB-SRL7
Description:	Group Lock Box - Steel, Red color powder coated, accommodates 1 Primary & 6 Secondary Padlocks.
Dimensions: L110 x W100 x D185mm.	
Brand: LOTO-LOK®	Origin: China
Weight:	Packaging:
	

Model No.:	GLB-WMB-R5
Description:	Group Lock Box - Steel construction, Wall Mounted.Upper & lowers hangers accommodates upto 12 Padlocks. 5 molded hooks inside box can hang multiple keys. Station without contents. Color: Red.
Dimensions: 230mm x 150mm x 90mm.	
Brand: LOTO-LOK®	Origin: China.
Weight:	Packaging: 01 No.
	

Model No.:	GLB-WHMST-R
Description:	Group Lock Box - Steel Powder coated. 12 Built-in Keys Hanger. Accommodates 14 Padlocks outside. Color: Red.
Dimensions: L 163 x W 85 x D 260mm.	
Brand: LOTO-LOK®	Origin: China
Weight:	Packaging:
	

Model No.:	GLB-AL-83
Description:	Group Lock Box - Aluminium Const. with tough Polycarbonate sliding cover & PTW holder. Accommodates upto 83 Padlocks with 4 key Hooks. Color: Red.
Dimensions: L 680 x W 340 x D 35mm.	
Brand: LOTO-LOK®	Origin: China
Weight:	Packaging:
	

GROUP LOCKOUT STATIONS

Model No.:	GLB-PLX18
Description:	Group Lock Box - Acrylic construction Hinged door, 6 keys hangers. Accommodates 16 Padlocks. Color: Red.
Dimensions: L200 x W150 x D90mm.	
Brand:	Origin: China
Weight:	Packaging:
	

Model No.:	GLB-WHP21-R
Description:	Group Lock Box - ABS & PC construction. Hinged door, 4 keys hangers. Accommodates 8 Padlocks. Color: Red.
Dimensions: L100 x W115 x D155mm.	
Brand:	Origin: China
Weight:	Packaging:
	

Model No.:	GLB-WHP22-R
Description:	Group Lock Box - ABS & PC construction. Hinged door, 6 keys hangers with key drop facility. Portable. Color: Red.
Dimensions: L200 x W90 x D162mm.	
Brand:	Origin: China
Weight:	Packaging:
	

Model No.:	GLB-WM-7
Description:	Group Lock Box - Steel Powder coated. 7 Key Hooks. Accommodates 7 Padlocks. Portable & Wall Mounting. Color: Red.
Dimensions: L 208 x W 208 x D 155mm.	
Brand: LOTO-LOK®	Origin: India.
Weight:	Packaging:
	

Model No.:	GLB-WH-12
Description:	Group Lock Box - Steel Powder coated. 15 Key Hooks. Accommodates 12 Padlocks. Portable & Wall Mounting. Color: Red.
Dimensions: L238 x W432 x D60mm.	
Brand: LOTO-LOK®	Origin: India.
Weight:	Packaging:
	

Model No.:	GLB-GL-1-8K
Description:	Group Lock Box - Steel Powder coated. 10 Key Hooks. Accommodates 10 Padlocks. Portable & Wall Mounting. Color: Red.
Dimensions: L310 x W305 x D80mm.	
Brand:	Origin: India.
Weight:	Packaging:
	

Model No.:	GLB-GLK-2
Description:	Group Lock Box - Steel Powder coated. 10 Key Hooks. Accommodates 9 Padlocks Portable & Wall Mounting. Color: Red.
Dimensions: L 310 x W 305 x D 80mm.	
Brand: LOTO-LOK®	Origin: India.
Weight:	Packaging:
	

Model No.:	GLB-GLK-3
Description:	Group Lock Box - Steel Powder coated. 40 Key Hooks. Accommodates 9 Padlocks Portable & Wall Mounting. Color: Red.
Dimensions: L 476 x W 318 x D 80mm.	
Brand: LOTO-LOK®	Origin: India.
Weight:	Packaging:
	

Model No.:	GLB-AR3KH
Description:	Group Lock Box - Acrylic construction with hinged door & 3 key hooks. Accommodates 5 Padlocks. Color: Red.
Dimensions: L150 x W150 x D60mm.	
Brand:	Origin: China
Weight:	Packaging:
	

GROUP LOCKOUT STATIONS

Model No.:	GLB-AR8KH
Description:	Group Lock Box - Acrylic construction with hinged door & 8 key hooks.
	Accommodates 8-10 Padlocks. Color: Red.
Dimensions: L 300 x W 190 x D 67mm.	
Brand:	Origin: China
Weight:	Packaging:

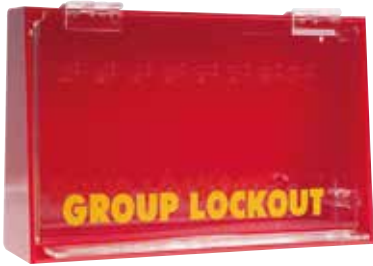

Model No.:	GLB-AR15KH
Description:	Group Lock Box - Acrylic construction with hinged door & 15 key hooks.
	Accommodates 10-15 Padlocks. Color: Red.
Dimensions: L 400 x W 190 x D 60mm.	
Brand:	Origin: China
Weight:	Packaging:

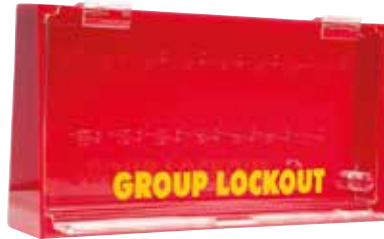

Model No.:	GLB-MB-4
Description:	Group Lock Box - SS304 Mini Box with 4 padlocks capacity. One Internal shelf accommodates keys and small fuses. Color: Yellow.
	Dimensions: L 158 mm x W 158 mm x D 54 mm.
Brand: LOTO-LOK®	Origin: China.
Weight:	Packaging: 01 No.



Model No.:	GLB-WMY-29H
Description:	Group Lock Box - Sliding door with key drop facility. Accommodates 29 Padlocks & 16 key hooks each. Color: Yellow.
	Dimensions: L 330 x W 265 x D 85mm.
Brand:	Origin: India.
Weight:	Packaging:



PADLOCK CABINETS

Model No.:	CABP-STLR-21-CF
Description:	Padlock Cabinet - 21 Locks Capacity.
	Durable Powder Coated Steel Cabinet with Clear Acrylic Fascia & 21 Hooks.
Dimensions: L450 x W375 x D100mm.	
Brand: LOTO-LOK®	Origin: India.
Weight:	Packaging:



Model No.:	CABP-STLR-28-CF
Description:	Padlock Cabinet - 28 Locks Capacity.
	Durable Powder Coated Steel Cabinet with Clear Acrylic Fascia & 28 Hooks.
Dimensions: L585 x W390 x D55mm.	
Brand: LOTO-LOK®	Origin: India.
Weight:	Packaging:



Model No.:	CABP-STLR-50-CF
Description:	Padlock Cabinet - 50 Locks Capacity.
	Durable Powder Coated Steel Cabinet with Clear Acrylic Fascia & 50 Hooks.
Dimensions: L 715 X W 505 X D 55 mm.	
Brand: LOTO-LOK®	Origin: India.
Weight:	Packaging:



Model No.:	CABP-STLR-60-CF
Description:	Padlock Cabinet - 60 Locks Capacity.
	Durable Powder Coated Steel Cabinet with Clear Acrylic Fascia & 60 Hooks.
Dimensions: L 860 X W 505 X D 55 mm.	
Brand: LOTO-LOK®	Origin: India.
Weight:	Packaging:



Model No.:	CABP-STLR-112
Description:	Padlock Cabinet - 112 Locks Capacity.
	Durable Powder Coated Cabinet with 112 Hooks & Steel door.
Dimensions: L584 x W393 x D139mm.	
Brand: LOTO-LOK®	Origin: India.
Weight:	Packaging:



Model No.:	CABP-STLR-220
Description:	Padlock Cabinet - 220 Locks Capacity.
	Durable Powder Coated Cabinet with 220 Hooks & Steel door.
Dimensions: L584 x W800 x D139mm.	
Brand: LOTO-LOK®	Origin: India.
Weight:	Packaging:



WALL MOUNTED PADLOCK STATIONS

Model No.:	PS-HANG6
Description:	Padlock Station - Wall mounted. 6 Locks Capacity. Color: Red
Dimensions: H 40 x W 140 x H 80mm.	
Brand: LOTO-LOK®	Origin: China
Weight:	Packaging:



Model No.:	PS-HANG12
Description:	Padlock Station - Wall mounted. 12 Locks Capacity. Color: Red
Dimensions: H 85 x W 27 x D 45mm.	
Brand: LOTO-LOK®	Origin: China
Weight:	Packaging:



Model No.:	PS-HANG18
Description:	Padlock Station - Wall mounted. 18 Locks Capacity. Color: Red
Dimensions: H 80 x W 400 x D 40mm.	
Brand: LOTO-LOK®	Origin: China
Weight:	Packaging:



Model No.:	PS-HANG24
Description:	Padlock Station - Wall mounted. 24 Locks Capacity. Color: Red
Dimensions: H 85 x W 530 x D 45mm.	
Brand: LOTO-LOK®	Origin: China
Weight:	Packaging:



KEY SAFE BOXES

Model No.:	KSB-3L
Description:	KEY SAFE BOX - 3 LOCK SYSTEM.
	1 Control Lock (KA) + 2 Secondary Locks (KD) with 2 internal shelves.
	1.2mm Steel Fabrication. Color: Grey.
Dimensions: H230 x W150 x D120mm.	
Brand: LOTO-LOK®	Origin: China
Weight:	Packaging:
	

Model No.:	KSB-5L
Description:	KEY SAFE BOX - 5 LOCK SYSTEM.
	1 Control Lock (KA) + 4 Secondary Locks (KD) with 2 internal shelves.
	1.2mm Steel Fabrication. Color: Grey.
Dimensions: H230 x W150 x D120mm.	
Brand: LOTO-LOK®	Origin: China
Weight:	Packaging:
	

Model No.:	KSB-7L
Description:	KEY SAFE BOX - 7 LOCK SYSTEM.
	1 Control Lock (KA) + 6 Secondary Locks (KD) with 2 internal shelves.
	1.2mm Steel Fabrication. Color: Grey.
Dimensions: H230 x W150 x D120mm.	
Brand: LOTO-LOK®	Origin: China
Weight:	Packaging:
	

Model No.:	KSB-5L300
Description:	KEY SAFE BOX - 5 LOCK SYSTEM.
	1 Control Lock (KA) + 4 Secondary Locks (KD) with 2 internal shelves.
	1.2mm Steel Fabrication. Color: Grey.
Dimensions: H305 x W305 x D104mm.	
Brand: LOTO-LOK®	Origin: China
Weight:	Packaging:
	

Model No.:	KSB-8L300
Description:	KEY SAFE BOX - 8 LOCK SYSTEM.
	1 Control Lock (KA) + 7 Secondary Locks (KD) with 2 internal shelves.
	1.2mm Steel Fabrication. Color: Grey.
Dimensions: H305 x W305 x D104mm.	
Brand: LOTO-LOK®	Origin: China
Weight:	Packaging:
	

Model No.:	KSB-5L300-H-STL
Description:	KEY SAFE BOX - 5 LOCK SYSTEM.
	1 Control Lock (KA) + 4 Secondary Locks (KD) with 28 Hooks for hanging keys. 1.2mm Mild Steel Fabrication. Color: Grey
Dimensions: H 305 x W 305 x D 104mm.	
Brand: LOTO-LOK®	Origin: China.
Weight:	Packaging: 01 No.
	

Model No.:	KSB-8L300-H-STL
Description:	KEY SAFE BOX - 8 LOCK SYSTEM.
	1 Control Lock (KA) + 4 Secondary Locks (KD) with 28 Hooks for hanging keys. 1.2mm Mild Steel Fabrication. Color: Grey
Dimensions: H 305 x W 305 x D 104mm.	
Brand: LOTO-LOK®	Origin: China.
Weight:	Packaging: 01 No.
	

Model No.:	KSB-5L300-H-SS
Description:	KEY SAFE BOX - 5 LOCK SYSTEM.
	1 Control Lock (KA) + 4 Secondary Locks (KD) with 28 Hooks for hanging keys. 1.2mm Stainless Steel 304 Fabrication. Color: Grey
Dimensions: H 305 x W 305 x D 104mm.	
Brand: LOTO-LOK®	Origin: China.
Weight:	Packaging: 01 No.
	

Model No.:	KSB-8L300-H-SS
Description:	KEY SAFE BOX - 8 LOCK SYSTEM.
	1 Control Lock (KA) + 4 Secondary Locks (KD) with 28 Hooks for hanging keys. 1.2mm Stainless Steel 304 Fabrication. Color: Grey
Dimensions: H 305 x W 305 x D 104mm.	
Brand: LOTO-LOK®	Origin: China.
Weight:	Packaging: 01 No.
	

LOK-FORCE™ KEY CABINETS

Model No.:	KC-LFLD-50
Description:	Key Cabinet - Rolled steel construction, Fixed hooks, 2 keys per lock, Plastic Key Tags & Wall mounting hardware included.
Dimensions:	240 x 300 x 75mm
Brand: LOK-FORCE™	Origin: China
Weight:	Packaging:



Model No.:	KC-LFHD-50
Description:	Key Cabinet - Rolled steel construction, Adjustable numbered hooks, 2 keys per lock, Plastic key Tags & Wall Mounting hardware included. Color: Grey.
Dimensions:	550 x 380 x 80mm
Brand: LOK-FORCE™	Origin: China
Weight:	Packaging:



Model No.:	KC-LFHD-100
Description:	Key Cabinet - Rolled steel construction, Adjustable numbered hooks, 2 keys per lock, Plastic key Tags & Wall Mounting hardware included. Color: Grey.
Dimensions:	550 x 380 x 80mm
Brand: LOK-FORCE™	Origin: China
Weight:	Packaging:



Model No.:	KC-LFHD-150
Description:	Key Cabinet - Rolled steel construction, Adjustable numbered hooks, 2 keys per lock, Plastic key Tags & Wall Mounting hardware included. Color: Grey.
Dimensions:	380 x 550 x 140mm
Brand: LOK-FORCE™	Origin: China
Weight:	Packaging:



Model No.:	KC-LFHD-200
Description:	Key Cabinet - Rolled steel construction, Adjustable numbered hooks, 2 keys per lock, Plastic key Tags & Wall Mounting hardware included. Color: Grey.
Dimensions:	380 x 550 x 140mm
Brand: LOK-FORCE™	Origin: China
Weight:	Packaging:



Model No.:	KC-LFHD-300
Description:	Key Cabinet - Rolled steel construction, Adjustable numbered hooks, 2 keys per lock, Plastic key Tags & Wall Mounting hardware included. Color: Grey.
Dimensions:	550 x 380 x 205mm
Brand: LOK-FORCE™	Origin: China
Weight:	Packaging:



Model No.:	KC-LFHD-400
Description:	Key Cabinet - Rolled steel construction, Adjustable numbered hooks, 2 keys per lock, Plastic key Tags & Wall Mounting hardware included. Color: Grey.
Dimensions:	730 x 550 x 140mm
Brand: LOK-FORCE™	Origin: China
Weight:	Packaging:



Model No.:	KC-LFHD-600
Description:	Key Cabinet - Rolled steel construction, Adjustable numbered hooks, 2 keys per lock, Plastic key Tags & Wall Mounting hardware included. Color: Grey.
Dimensions:	730 x 550 x 205mm
Brand: LOK-FORCE™	Origin: China
Weight:	Packaging:



Model No.:	KC-LFHD-1170
Description:	Key Cabinet - Rolled steel construction, Adjustable numbered hooks, 2 keys per lock, Plastic key Tags & Wall Mounting hardware included. Color: Grey.
Dimensions:	1300 x 730 x 250mm
Brand: LOK-FORCE™	Origin: China
Weight:	Packaging:



LOK-FORCE™ KEY CABINETS

Model No.:	KC-LFDKC-40
Description:	Key Cabinet Digital - Battery operated, Rolled steel construction, Fixed hooks with numbered key tags, 2 keys per lock, Plastic Key Tags & Wall mounting hardware included.
	Dimensions: 270 x 308 x 65mm
Brand: LOK-FORCE™	Origin: China
Weight:	Packaging:



Model No.:	KC-LFDKC-60
Description:	Key Cabinet Digital - Battery operated, Rolled steel construction, Fixed hooks with numbered key tags, 2 keys per lock, Plastic Key Tags & Wall mounting hardware included.
	Dimensions: 432 x 330 x 65mm
Brand: LOK-FORCE™	Origin: China
Weight:	Packaging:



Model No.:	KC-LFDKC-120
Description:	Key Cabinet Digital - Battery operated, Rolled steel construction, Fixed hooks with numbered key tags, 2 keys per lock, Plastic Key Tags & Wall mounting hardware included.
	Dimensions: 375 x 432 x 65mm
Brand: LOK-FORCE™	Origin: China
Weight:	Packaging:



Model No.:	KC-LFEKC-3
Description:	Key Cabinet Emergency - Rolled steel construction, 3 fixed key hooks & hammer, 2 keys per lock, Plastic Key Tags & Wall mounting hardware included.
	Dimensions: 120 x 150 x 80mm
Brand: LOK-FORCE™	Origin: China
Weight:	Packaging:

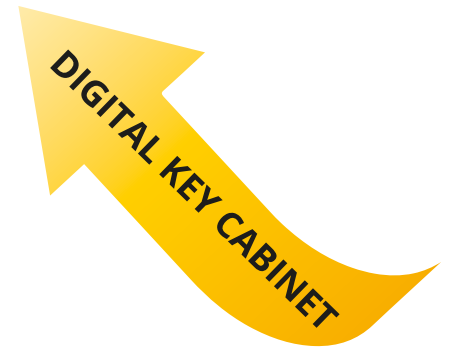

Model No.:	CAB-SB
Description:	Suggestion Box with external pocket for holding forms, Rolled steel construction, 2 keys per lock, Wall mounting hardware included.
	Dimensions: 215 x 185 x 150mm
Brand: LOK-FORCE™	Origin: China
Weight:	Packaging:

Model No.:	KT-50
Description:	Plastic Key Tags - Normal. Assorted colors: Red, Yellow, Green, Blue, White & Black.
	Dimensions:
Brand: LOK-FORCE™	Origin: China
Weight:	Packaging:



Model No.:	KT-63
Description:	Plastic Key Tags - Heavy Duty Assorted colors: Red, Yellow, Green, Blue, White, Orange & Purple.
	Dimensions:
Brand: LOK-FORCE™	Origin: China
Weight:	Packaging:



Model No.:	KT-52
Description:	Plastic Key Tag - White slotted.
	Dimensions:
Brand: LOK-FORCE™	Origin: China
Weight:	Packaging:



KEY CABINETS

Model No.:	KCG10K
Description:	Key Cabinet - 10 Key Capacity, with plastic key tags and indexing card.
	Color: Grey.
Dimensions: W220 x D45 x H110mm.	
Brand: HELIX	Origin: China
Weight:	Packaging:
Till Stocks Last	
	

Model No.:	KCG20K
Description:	Key Cabinet - 20 Key Capacity, with plastic key tags and indexing card.
	Color: Grey.
Dimensions: W220 x D45 x H110mm.	
Brand: HELIX	Origin: China
Weight:	Packaging:
Till Stocks Last	
	

Model No.:	KCG30K
Description:	Key Cabinet - 30 Key Capacity, with plastic key tags and indexing card.
	Color: Grey.
Dimensions: W190 x D45 x H150mm.	
Brand: HELIX	Origin: China
Weight:	Packaging:
Till Stocks Last	
	

Model No.:	KCG80K
Description:	Key Cabinet - 80 Key Capacity, with plastic key tags and indexing card.
	Color: Grey.
Dimensions: W 275 x D 70 x H 275mm.	
Brand: HELIX	Origin: China
Weight:	Packaging:
Till Stocks Last	
	

Model No.:	KCG100K
Description:	Key Cabinet - 100 Key Capacity, with plastic key tags and indexing card.
	Color: Grey.
Dimensions: W 310 x D 70 x H 400mm.	
Brand: HELIX	Origin: China
Weight:	Packaging:
Till Stocks Last	
	

Model No.:	KC-30-CF
Description:	Key Cabinet - Manufactured by Metal Sheet with locking locking arrangement, 30 Keys Capacity with Clear Fascia.
Dimensions: L 360 x W 258 x D 55 mm.	
Brand: LOTO-LOK®	Origin: China.
Weight:	Packaging:
	

Model No.:	KC-60-CF
Description:	Key Cabinet - Manufactured by Metal Sheet with locking locking arrangement, 60 Keys Capacity with Clear Fascia.
Dimensions: L 460 x W 390 x D 55mm.	
Brand: LOTO-LOK®	Origin: China.
Weight:	Packaging:
	

Model No.:	KC-100-CF
Description:	Key Cabinet - Manufactured by Metal Sheet with locking locking arrangement, 100 Keys Capacity with Clear Fascia.
Dimensions: H 590 x W 520 x D 60 mm.	
Brand: LOTO-LOK®	Origin: China.
Weight:	Packaging:
	

Model No.:	KC-CF-320
Description:	Key Cabinet - 320 Keys capacity Durable Powder Coated Steel Cabinet with Clear Acrylic Fascia. Color: Yellow.
Dimensions: L 790 x W 460 x D 105mm.	
Brand: LOTO-LOK®	Origin: India
Weight:	Packaging:
	

LOTO POUCHES & BAGS

Model No.:	BG-RD21BP
Description:	LOTO BAG - Belt Pouch
	1680D Polyester heavy duty construction. 2 Pockets, Color: Red.
Dimensions:	20.5 x 10 x 14cms.
Brand: LOK-FORCE™	Origin: China
Weight:	Packaging:
	

Model No.:	BG-YW36MN
Description:	LOTO BAG - Mini Tote
	1680D Polyester heavy duty construction. Color: Yellow.
Dimensions:	36 x 13 x 15cms.
Brand: LOK-FORCE™	Origin: China
Weight:	Packaging:
	

Model No.:	BG-YR45SB
Description:	LOTO BAG - Shoulder
	1680D Polyester heavy duty construction. Multi pockets for organising different LOTO products & small tools. Color: Yellow/Red.
Dimensions:	45 x 22 x 32cms.
Brand: LOK-FORCE™	Origin: China
Weight:	Packaging:
	

Model No.:	BG-RD61WP
Description:	LOTO BAG - Waist Pouch - Heavy Duty,
	Extremely durable, Red color, 3 Pocket Waist Pouch manufactured from 1680D Grade Polyester. Color: Red
Dimensions:	61 x 16. x 17cms.
Brand: LOK-FORCE™	Origin: China
Weight:	Packaging:
	

Model No.:	BG-YR32SM
Description:	LOTO BAG - Hand Carry Bag - Small
	Heavy Duty Red color bag, Material 1680D Polyester. Color: Yellow / Red.
Dimensions:	31.5 x 23 x 27cms.
Brand: LOK-FORCE™	Origin: China
Weight:	Packaging:
	

Model No.:	BG-YR39MD
Description:	LOTO BAG - Hand Carry Bag - Medium
	Heavy Duty Red color bag, Material 1680D Polyester. Color: Yellow / Red.
Dimensions:	39 x 26 x 28cms.
Brand: LOK-FORCE™	Origin: China
Weight:	Packaging:
	

Model No.:	BG-YR47LG
Description:	LOTO BAG - Trolley Bag - Large
	Heavy duty construction w / Trolley Wheels. Material 1680D Polyester. Color: Yellow / Red.
Dimensions:	45 x 27 x 30cms.
Brand: LOK-FORCE™	Origin: China
Weight:	Packaging:
	

Model No.:	BG-RD62EG
Description:	Electrical Gear Bag - Duffle Tote
	Color: Red. With Silk Screen printed "ELECTRICAL GEAR" on front side of bag.
Dimensions:	62 x 32 x 37cms.
Brand: LOK-FORCE™	Origin: China
Weight:	Packaging:
	

★
POUCHES & BAGS CAN BE CUSTOMIZED WITH COMPANY NAMES / LOGOS BASED ON MINIMUM QUANTITIES.
★

E-MAIL: INFO@LOTOSAFETYPRODUCTS.COM

LOCKOUT / TAGOUT COMPLIANCE CENTRES

Model No.:	LSP-01
Description:	SDS STATION - Safety Data Sheets
	includes PVC coated wire rack on panel + one binder to store up to 300 data sheets.
Dimensions: L 585 X W 355 X D 115 mm.	
Brand: LOTO-LOK®	Origin: India
Weight:	Packaging:
	

Model No.:	LSP-02
Description:	SDS STATION - Safety Data Sheets
	includes PVC coated wire rack on panel + two binders to store up to 600 data sheets.
Dimensions: L 555 X W 740 X D 115 mm.	
Brand: LOTO-LOK®	Origin: India
Weight:	Packaging:
	

Model No.:	MSDS-9000-07	
Description:	SDS STATION - Document Storage Box	
	(Empty Box Only). Color: Red.	
Dimensions: 11" x 8.5" x 1.63".		
Brand: Manual-Pak by Custom-Pak	Origin: USA	
Weight:	Packaging:	
		

SCAFFOLDING, LADDER & MICROTAGS

Model No.:	TAG-SCAF-THI
Description:	SCAFFOLDING TAG - HOLDER. Material: ABS/PA6.
Size :	L 305mm x W 92mm.
Brand: LOTO-LOK®	Origin: China
Weight:	Packaging:



Model No.:	TAG-SCAF-THI
Description:	SCAFFOLDING TAG - INSERT. Material: PVC.
Size :	L 210mm x W 85mm.
Brand: LOTO-LOK®	Origin: China
Weight:	Packaging:



Model No.:	TAG-SCAFF-BOX
Description:	SCAFFOLDING TAG HOLDER & INSERT Holder Material: ABS/PA6. Insert Material: PVC.
Size :	
Brand: LOTO-LOK®	Origin: China
Weight:	Packaging:

Packaging: 10 Nos. Holders + 20 Nos. Inserts + 02 Nos. Marker Pen per BOX



Model No.:	TAG-LADR-THI
Description:	LADDER INSPECTION - HOLDER.
Size :	L 183mm x W 55.7mm.
Brand:	Origin: China
Weight:	Packaging:



Model No.:	TAG-LADR-THI
Description:	LADDER INSPECTION - INSERT.
Size :	L 183mm x W 52mm.
Brand:	Origin: China
Weight:	Packaging:



Model No.:	TAG-MICR-THI
Description:	Microtag Holder & Insert with Cable Tie.
Size :	L 81mm x W 39mm.
Brand:	Origin: China
Weight:	Packaging:



Model No.:	DH-ACY-YELLOW
Description:	Document Holder - with Clear Door and Group Locking facility. Acrylic construction. Wall mounting. Color: Yellow.
Dimensions:	L410 X W260mm.
Brand: LOTO-LOK®	Origin: China
Weight:	Packaging:



Model No.:	DH-PVC-PTW
Description:	Document Holder - Flexible Sheeting Permit Holder with zip lock & metal eyelet. PTW can be secured with uniquely numbered color coded cable ties.
Dimensions:	L325 mm x W290mm.
Brand: LOTO-LOK®	Origin: China
Weight:	Packaging:





LOTO VINYL STICKERS

Model No.:	RWV-01
Description:	STICKER VINYL - Lockout / Tagout
	Self-Adhesive LOTO Sticker, stick on Equipment & Machines as Visual Aids.
Dimensions: L300 x W150mm. Type: Vertical.	
Brand: LOTO-LOK®	Origin: India
Weight:	Packaging:
	

Model No.:	RWH-02
Description:	STICKER VINYL - Lockout / Tagout
	Self-Adhesive LOTO Sticker, stick on Equipment & Machines as Visual Aids.
Dimensions: W300 x L150mm. Type: Horizontal.	
Brand: LOTO-LOK®	Origin: India
Weight:	Packaging:
	

Model No.:	BWH-03
Description:	STICKER VINYL - Lockout / Tagout
	Self-Adhesive LOTO Sticker, stick on Equipment & Machines as Visual Aids.
Dimensions: W300 x L150mm. Type: Horizontal.	
Brand: LOTO-LOK®	Origin: India
Weight:	Packaging:
	

Model No.:	BWV-04
Description:	STICKER VINYL - Lockout / Tagout
	Self-Adhesive LOTO Sticker, stick on Equipment & Machines as Visual Aids.
Dimensions: L300 x W150mm. Type: Vertical.	
Brand: LOTO-LOK®	Origin: India
Weight:	Packaging:
	

Model No.:	BWH-05
Description:	STICKER VINYL - Lockout / Tagout
	Self-Adhesive LOTO Sticker, stick on Equipment & Machines as Visual Aids.
Dimensions: W300 x L150mm. Type: Horizontal.	
Brand: LOTO-LOK®	Origin: India
Weight:	Packaging:
	

Model No.:	RBH-06
Description:	STICKER VINYL - Lockout / Tagout
	Self-Adhesive LOTO Sticker, stick on Equipment & Machines as Visual Aids.
Dimensions: W300 x L150mm. Type: Horizontal.	
Brand: LOTO-LOK®	Origin: India
Weight:	Packaging:
	

Model No.:	RBV-07
Description:	STICKER VINYL - Lockout / Tagout
	Self-Adhesive LOTO Sticker, stick on Equipment & Machines as Visual Aids.
Dimensions: L300 x W150mm. Type: Vertical.	
Brand: LOTO-LOK®	Origin: India
Weight:	Packaging:
	

Model No.:	BBH-08
Description:	STICKER VINYL - Lockout / Tagout
	Self-Adhesive LOTO Sticker, stick on Equipment & Machines as Visual Aids.
Dimensions: W300 x L150mm. Type: Horizontal.	
Brand: LOTO-LOK®	Origin: India
Weight:	Packaging:
	

Model No.:	YRH-09
Description:	STICKER VINYL - Lockout / Tagout
	Self-Adhesive LOTO Sticker, stick on Equipment & Machines as Visual Aids.
Dimensions: W300 x L150mm. Type: Horizontal.	
Brand: LOTO-LOK®	Origin: India
Weight:	Packaging:
	

LOTO VINYL STICKERS

Model No.:	RBH-10
Description:	STICKER VINYL - Lockout / Tagout
	Self-Adhesive LOTO Sticker, stick on Equipment & Machines as Visual Aids.
Dimensions: W300 x L150mm. Type: Horizontal.	
Brand: LOTO-LOK®	Origin: India
Weight:	Packaging:



Model No.:	RBH-11
Description:	STICKER VINYL - Lockout / Tagout
	Self-Adhesive LOTO Sticker, stick on Equipment & Machines as Visual Aids.
Dimensions: W300 x L150mm. Type: Horizontal.	
Brand: LOTO-LOK®	Origin: India
Weight:	Packaging:



Model No.:	YBH-12
Description:	STICKER VINYL - Lockout / Tagout
	Self-Adhesive LOTO Sticker, stick on Equipment & Machines as Visual Aids.
Dimensions: W300 x L150mm. Type: Horizontal.	
Brand: LOTO-LOK®	Origin: India
Weight:	Packaging:



Model No.:	RBH-13
Description:	STICKER VINYL - Lockout / Tagout
	Self-Adhesive LOTO Sticker, stick on Equipment & Machines as Visual Aids.
Dimensions: W300 x L150mm. Type: Horizontal.	
Brand: LOTO-LOK®	Origin: India
Weight:	Packaging:



LOTO POSTERS

Model No.:	LP-01
Description:	POSTER - Lockout / Tagout. Made from durable Vinyl (Vertical).
Dimensions: L 600 x W 450mm.	
Brand: LOTO-LOK®	Origin: India
Weight:	Packaging:



Model No.:	LP-02
Description:	POSTER - Lockout / Tagout. Made from durable Vinyl (Vertical).
Dimensions: L 600 x W 450mm.	
Brand: LOTO-LOK®	Origin: India
Weight:	Packaging:



Model No.:	LP-03
Description:	POSTER - Lockout / Tagout. Made from durable Vinyl (Vertical).
Dimensions: L 600 x W 450mm.	
Brand: LOTO-LOK®	Origin: India
Weight:	Packaging:



Model No.:	LP-04
Description:	POSTER - Lockout / Tagout. Made from durable Vinyl (Vertical).
Dimensions: L 600 x W 450mm.	
Brand: LOTO-LOK®	Origin: India
Weight:	Packaging:



Model No.:	LP-05
Description:	POSTER - Lockout / Tagout. Made from durable Vinyl (Vertical).
Dimensions: L 600 x W 450mm.	
Brand: LOTO-LOK®	Origin: India
Weight:	Packaging:



Model No.:	LP-06
Description:	POSTER - Lockout / Tagout. Made from durable Vinyl (Vertical).
Dimensions: L 600 x W 450 mm.	
Brand: LOTO-LOK®	Origin: India
Weight:	Packaging:



Model No.:	LP-07
Description:	POSTER - Lockout / Tagout. Made from durable Vinyl (Vertical).
Dimensions: L 600 x W 450mm.	
Brand: LOTO-LOK®	Origin: India
Weight:	Packaging:



ELECTRIC SHOCK & CRANE SAFETY POSTERS

Model No.:	EL-01
Description:	Poster - Electric Shock (Vertical). GB Standard, Manufactured from durable plastic laminate
Dimensions:	750 x 500mm.
Brand:	LOTO-LOK® Origin: India
Weight: Packaging:
	

Model No.:	EL-02
Description:	Tips Poster - Electric Safety (Vertical).
Dimensions:	750 x 500mm.
Brand:	LOTO-LOK® Origin: India
Weight: Packaging:
	

Model No.:	EL-04
Description:	Poster - Electric Shock (Vertical).
Dimensions:	750 x 500mm.
Brand:	LOTO-LOK® Origin: India
Weight: Packaging:
	

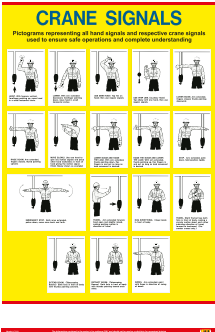
Model No.:	CS-01
Description:	Poster - Crane Signals (Vertical).
Dimensions:	750 x 500mm.
Brand:	LOTO-LOK® Origin: India
Weight: Packaging:
	

Model No.:	CS-02
Description:	Poster - Crane Safety (Vertical).
Dimensions:	750 x 500mm.
Brand:	LOTO-LOK® Origin: India
Weight: Packaging:
	

FIRST AID POSTERS

Model No.:	FA-01
Description:	Poster - First Aid Eye Injuries (Vertical).
Dimensions:	750 x 500mm.
Brand: LOTO-LOK®	Origin: India
Weight:	Packaging:

Model No.:	FA-02
Description:	Poster - First Aid Chemical and Caustics (Vertical).
Dimensions:	750 x 500mm.
Brand: LOTO-LOK®	Origin: India
Weight:	Packaging:

Model No.:	FA-03
Description:	Poster - First Aid Burns and Scalds (Vertical).
Dimensions:	750 x 500mm.
Brand: LOTO-LOK®	Origin: India
Weight:	Packaging:

Model No.:	FA-04
Description:	Poster - First Aid Chest Injuries (Vertical).
Dimensions:	750 x 500mm.
Brand: LOTO-LOK®	Origin: India
Weight:	Packaging:

Model No.:	FA-05
Description:	Poster - First Aid Artificial Respiration (Vertical).
Dimensions:	750 x 500mm.
Brand: LOTO-LOK®	Origin: India
Weight:	Packaging:

Model No.:	FA-06
Description:	Poster - First Aid Neck and Back Injuries (Vertical).
Dimensions:	750 x 500mm.
Brand: LOTO-LOK®	Origin: India
Weight:	Packaging:

Model No.:	FA-07
Description:	Poster - First Aid Stomach Injuries (Vertical).
Dimensions:	750 x 500mm.
Brand: LOTO-LOK®	Origin: India
Weight:	Packaging:

Model No.:	FA-08
Description:	Poster - First Aid Heart Attacks (Vertical).
Dimensions:	750 x 500mm.
Brand: LOTO-LOK®	Origin: India
Weight:	Packaging:

Model No.:	FA-09
Description:	Poster - First Aid Head Injuries and Nosebleeds (Vertical).
Dimensions:	750 x 500mm.
Brand: LOTO-LOK®	Origin: India
Weight:	Packaging:

FIRST AID POSTERS

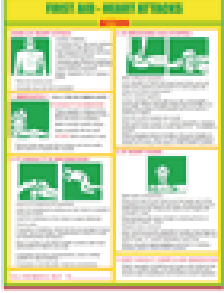
Model No.:	FA-10
Description:	Poster - First Aid Bleeding Cuts and Wounds (Vertical).
Dimensions: 750 x 500mm.	
Brand: LOTO-LOK®	Origin: India
Weight:	Packaging:
	

Model No.:	FA-11
Description:	Poster - First Aid Fits, Convulsions and Choking (Vertical).
Dimensions: 750 x 500mm.	
Brand: LOTO-LOK®	Origin: India
Weight:	Packaging:
	

Model No.:	FA-12
Description:	Poster - First Aid Fractures Dislocations and Sprains (Vertical).
Dimensions: 750 x 500mm.	
Brand: LOTO-LOK®	Origin: India
Weight:	Packaging:
	

Model No.:	FA-13
Description:	Poster - First Aid Transporting the Injured (Vertical).
Dimensions: 750 x 500mm.	
Brand: LOTO-LOK®	Origin: India
Weight:	Packaging:
	

LOCKOUT / TAGOUT & ARC FLASH PPE SAVES LIVES

Is your facility compliant to OSHA 29 CFR 1910.147 standard?

LOCKOUT / TAGOUT

 Electrical Lockouts

 Mechanical Lockouts

 Safety Padlocks

 Danger Tags

 Group Lockout

 Identification

 Assessment

 Demonstration

 Supply

 Installation Support

LOTO DEVICES, PADLOCKS AND TAGS FOR ISOLATION OF HAZARDOUS ENERGY



Safety Lockout Padlocks



Lockout Hasps



Circuit Breaker Lockouts



KAB-O-LOK Cable Lockouts



Mechanical Lockouts



Plug Lockouts



Panel Lockouts



Group Lock Box



Key Safe Box



Loto Stations



Key & Padlock Cabinets



Lockout Tags

ELECTRICAL SAFETY SOLUTIONS ARC FLASH PROTECTION PPE



Wall Mounted Rescue Kit



Arc Rated Balaclava



Arc Rated Helmet & Visor



CEI IEC 61243-1 Contact Voltage Detectors



Earthing & Short circuiting kits



Voltage Detectors



LOTO SAFETY REQUISITES TRADING L.L.C.

Belresheed Warehouse No.7, Next To Jacky's Electronics, Nad Al Hamar, P.O Box 114738, Dubai - UAE

Tel: +971-4-4539779 E-mail: info@lotosafetyproducts.com www.lotosafetyproducts.com